

- = CARPETED AREA
- ⊕ = EXTERIOR RECEPTACLE
- HB = EXTERIOR HOSE BIBB
- ⊙ = FLUSH MOUNT RECESSED-STYLE LIGHT
- ⊙ = CEILING LIGHT

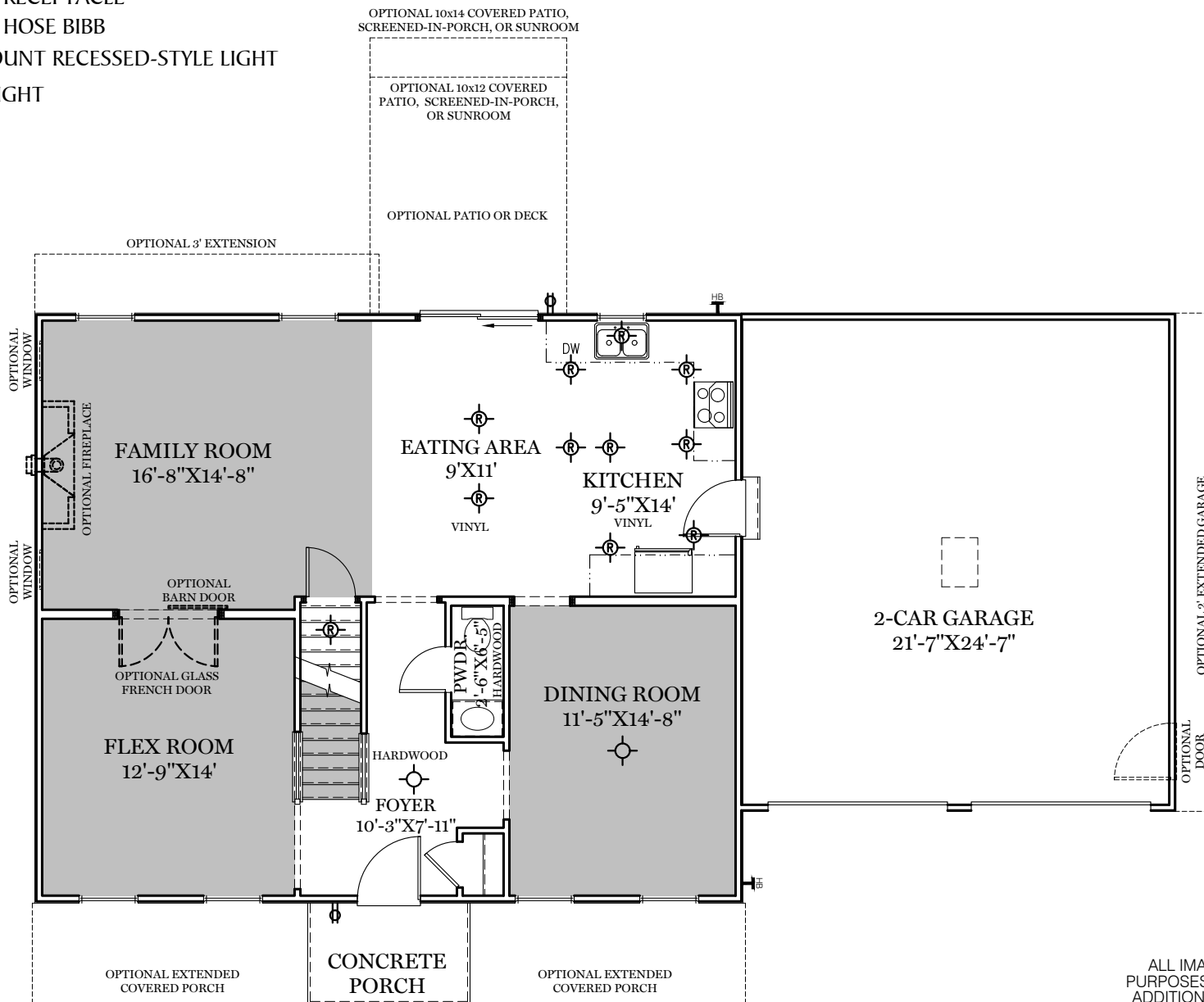

ALL IMAGES ARE FOR ARTISTIC PURPOSES ONLY AND MAY CONTAIN ADDITIONAL FEATURES OR DESIGN OPTIONS NOT AVAILABLE ON ALL HOME PLANS AND IN ALL NEIGHBORHOODS. ROOM SIZE DIMENSIONS AND SQUARE FOOTAGES ARE APPROXIMATE. CONTACT SALES AGENT FOR MORE INFORMATION. TERMS AND CONDITIONS APPLY. [HTTPS://EGSTOLTZFUSHOMES.COM/TERMS-AND-CONDITIONS/](https://EGSTOLTZFUSHOMES.COM/TERMS-AND-CONDITIONS/)

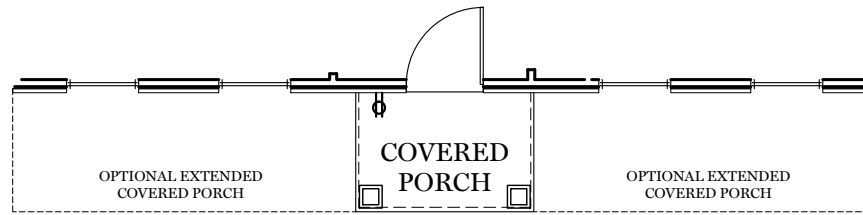

CLASSIC FLOOR PLAN

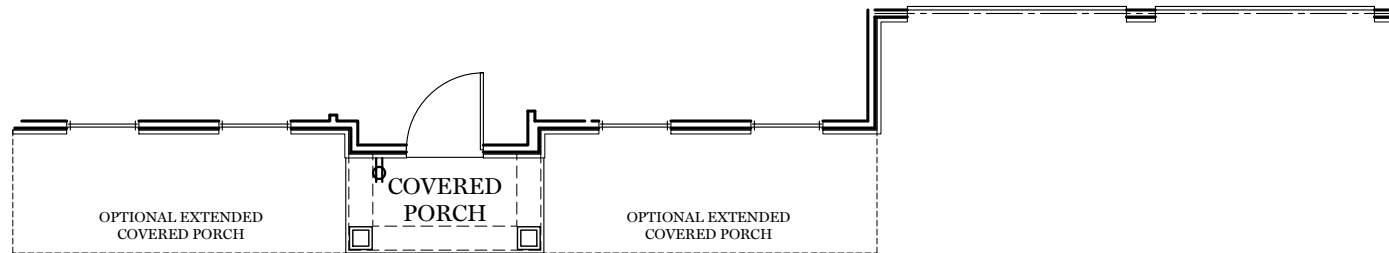

AMERICAN FLOOR PLAN

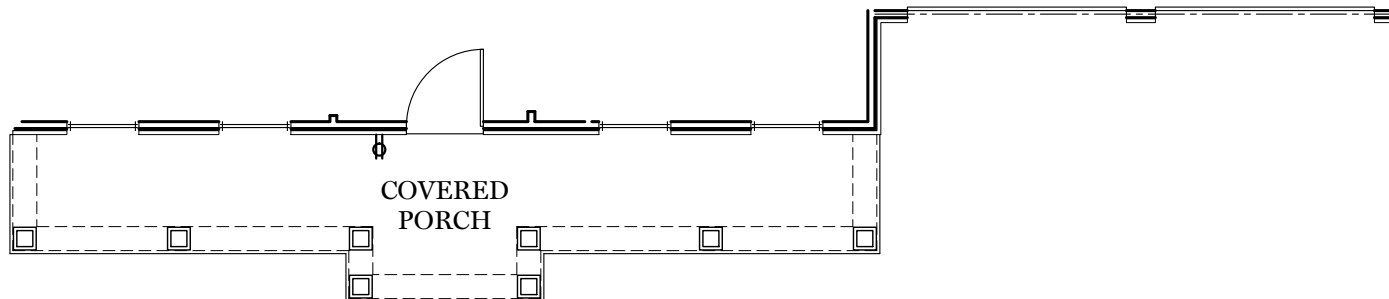

HERITAGE FLOOR PLAN

1st Floor Plan

BRIARWOOD

ALL IMAGES ARE FOR ARTISTIC PURPOSES ONLY AND MAY CONTAIN ADDITIONAL FEATURES OR DESIGN OPTIONS NOT AVAILABLE ON ALL HOME PLANS AND IN ALL NEIGHBORHOODS. ROOM SIZE DIMENSIONS AND SQUARE FOOTAGES ARE APPROXIMATE. CONTACT SALES AGENT FOR MORE INFORMATION. TERMS AND CONDITIONS APPLY. [HTTPS://EGSTOLTZFUSHOMES.COM/TERMS-AND-CONDITIONS/](https://EGSTOLTZFUSHOMES.COM/TERMS-AND-CONDITIONS/)

PDF LAST UPDATED 12/9/2022

■ = CARPETED AREA

⊙ = FLUSH MOUNT RECESSED-STYLE LIGHT

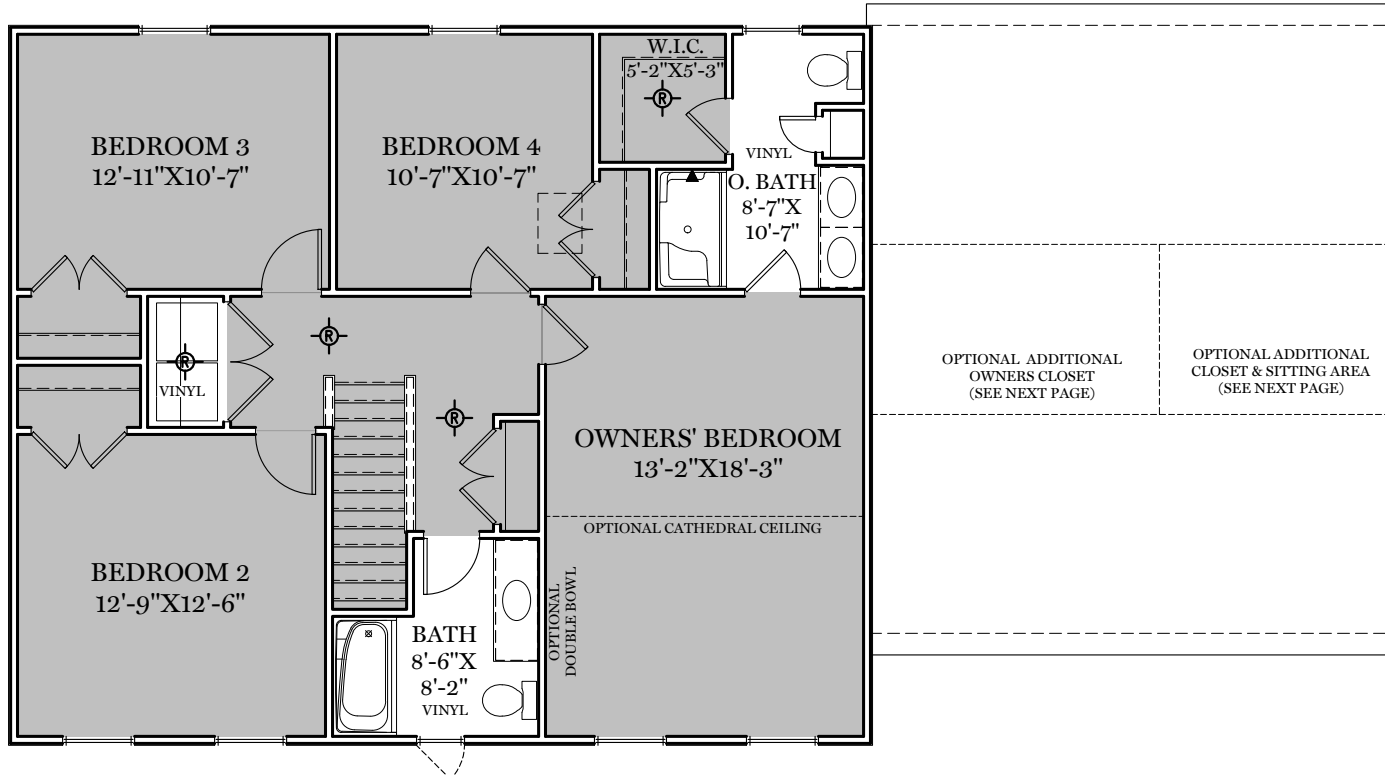

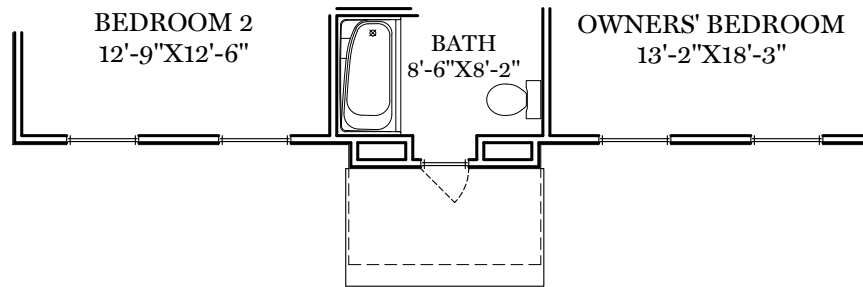

AMERICAN FLOOR PLAN

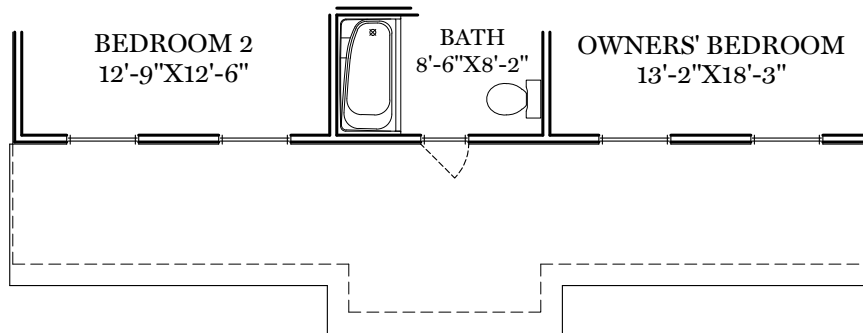

HERITAGE FLOOR PLAN

ALL IMAGES ARE FOR ARTISTIC PURPOSES ONLY AND MAY CONTAIN ADDITIONAL FEATURES OR DESIGN OPTIONS NOT AVAILABLE ON ALL HOME PLANS AND IN ALL NEIGHBORHOODS. ROOM SIZE DIMENSIONS AND SQUARE FOOTAGES ARE APPROXIMATE. CONTACT SALES AGENT FOR MORE INFORMATION. TERMS AND CONDITIONS APPLY. [HTTPS://EGSTOLTZFUSHOMES.COM/TERMS-AND-CONDITIONS/](https://EGSTOLTZFUSHOMES.COM/TERMS-AND-CONDITIONS/)

OPTIONAL LUXURY BATH
(MOVES OWNERS CLOSET AS SHOWN)

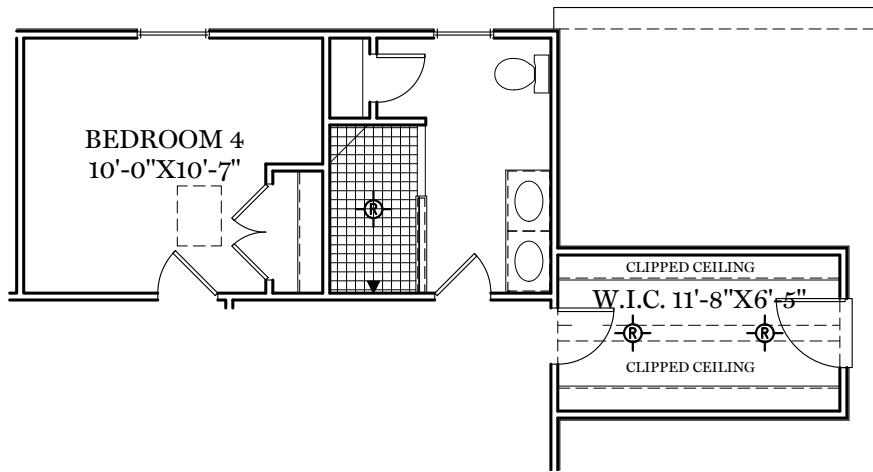

OPTIONAL RETREAT BATH
(MOVES W.I.C. AS SHOWN)

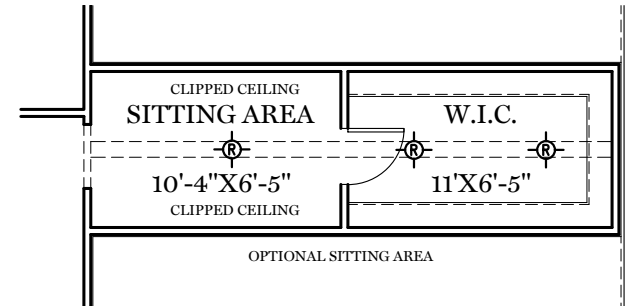
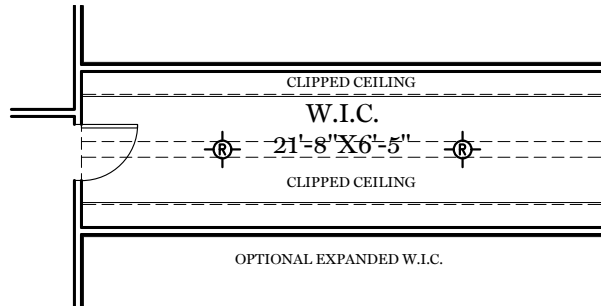
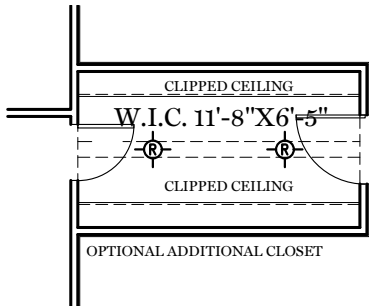
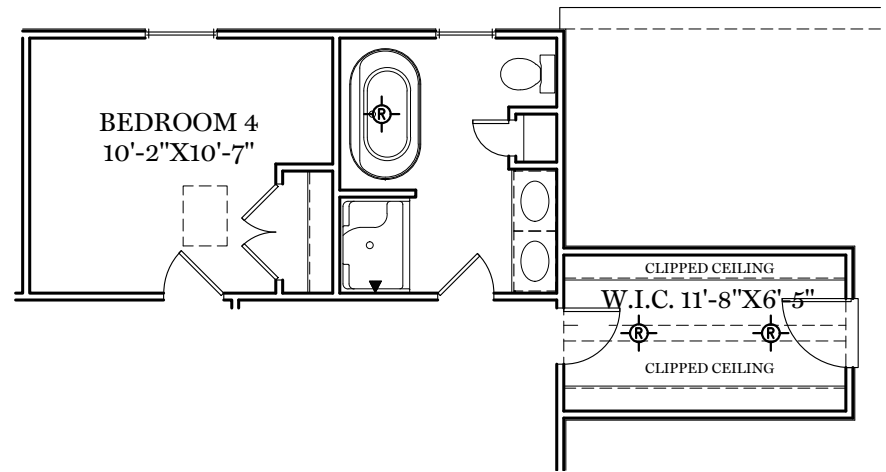

ALL IMAGES ARE FOR ARTISTIC PURPOSES ONLY AND MAY CONTAIN ADDITIONAL FEATURES OR DESIGN OPTIONS NOT AVAILABLE ON ALL HOME PLANS AND IN ALL NEIGHBORHOODS. ROOM SIZE DIMENSIONS AND SQUARE FOOTAGES ARE APPROXIMATE. CONTACT SALES AGENT FOR MORE INFORMATION. TERMS AND CONDITIONS APPLY. [HTTPS://EGSTOLTZFUSHOMES.COM/TERMS-AND-CONDITIONS/](https://EGSTOLTZFUSHOMES.COM/TERMS-AND-CONDITIONS/)

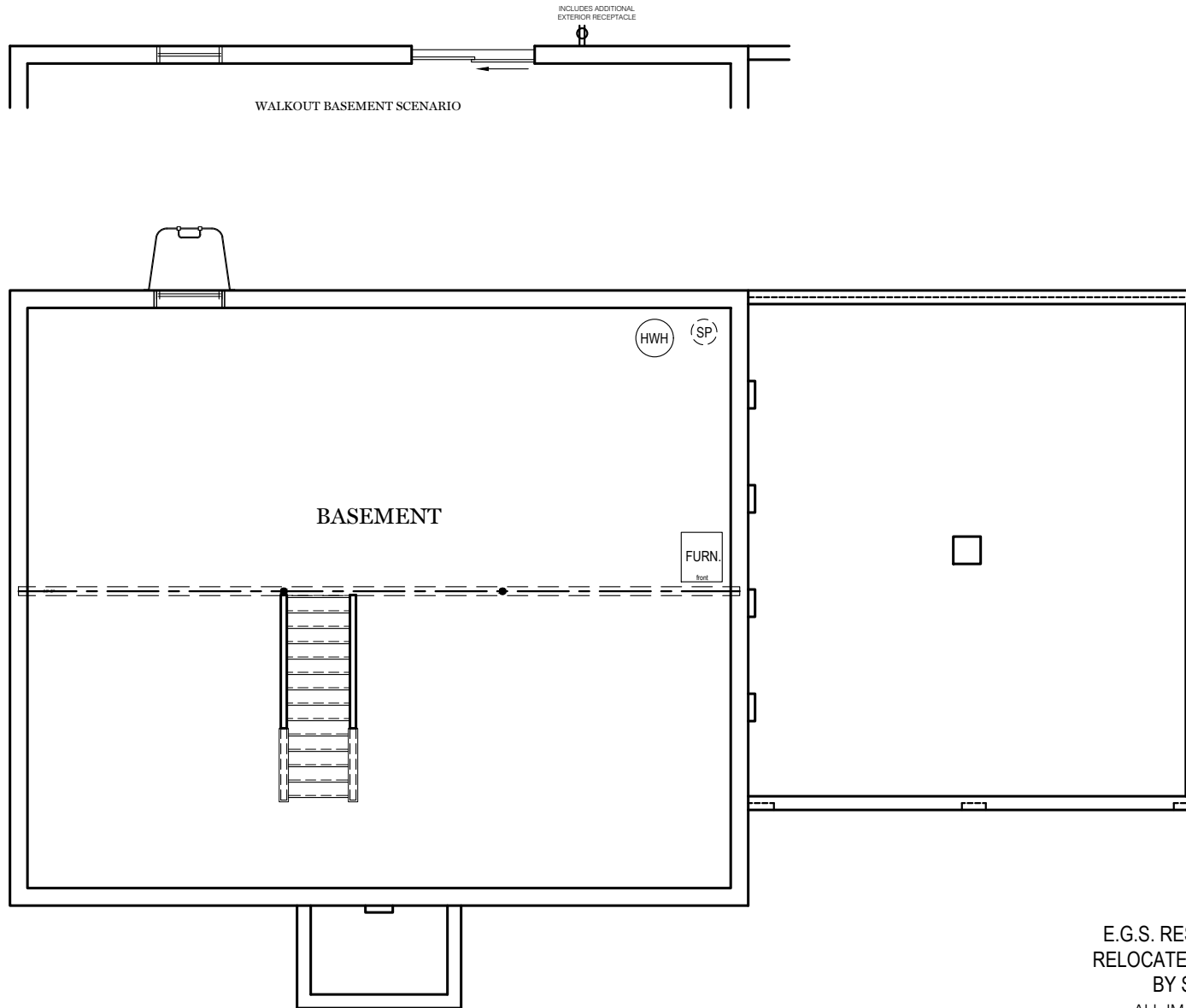

E.G.S. RESERVES THE RIGHT TO
RELOCATE MECHANICALS AS REQ.
BY SITE CONDITIONS

ALL IMAGES ARE FOR ARTISTIC
PURPOSES ONLY AND MAY CONTAIN
ADDITIONAL FEATURES OR DESIGN
OPTIONS NOT AVAILABLE ON ALL
HOME PLANS AND IN ALL
NEIGHBORHOODS. ROOM SIZE
DIMENSIONS AND SQUARE FOOTAGES
ARE APPROXIMATE. CONTACT SALES
AGENT FOR MORE INFORMATION.
TERMS AND CONDITIONS APPLY.
[HTTPS://EGSTOLTZFUSHOMES.COM/
TERMS-AND-CONDITIONS/](https://EGSTOLTZFUSHOMES.COM/TERMS-AND-CONDITIONS/)

TRADITIONAL** FLOOR PLAN SHOWN

Foundation

BRIARWOOD

** TRADITIONAL FLOOR
PLAN ONLY AVAILABLE IN
SELECT COMMUNITIES

PDF LAST UPDATED 12/9/2022

- = CARPETED AREA
- ⊗ = FLUSH MOUNT RECESSED-STYLE LIGHT

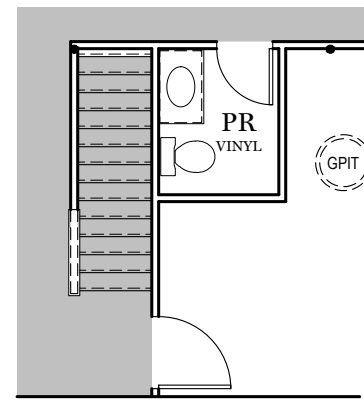
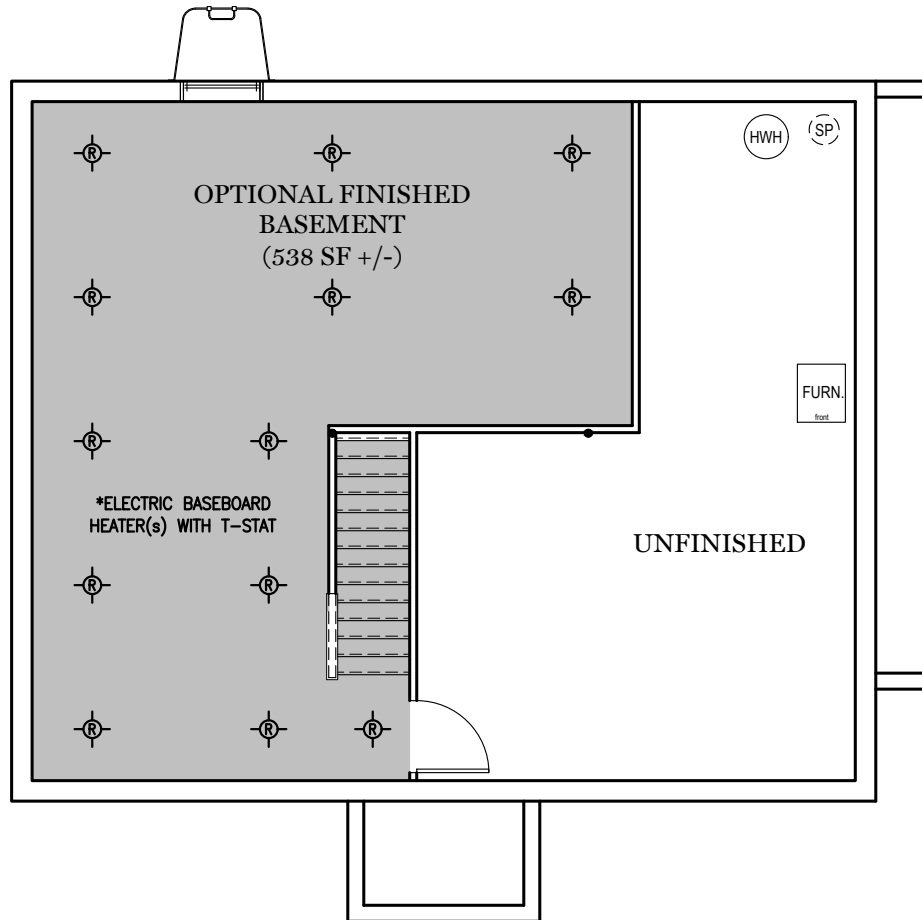

OPTIONAL FINISHED POWDER ROOM (+ 34 SF)

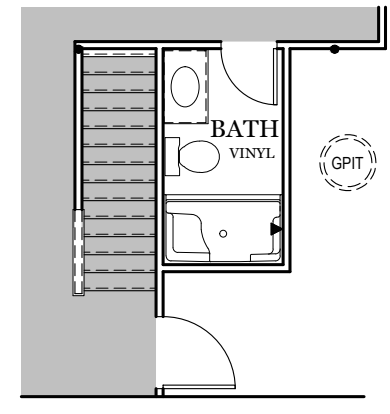

OPTIONAL FINISHED BATHROOM (+ 50 SF)

ALL IMAGES ARE FOR ARTISTIC PURPOSES ONLY AND MAY CONTAIN ADDITIONAL FEATURES OR DESIGN OPTIONS NOT AVAILABLE ON ALL HOME PLANS AND IN ALL NEIGHBORHOODS. ROOM SIZE DIMENSIONS AND SQUARE FOOTAGES ARE APPROXIMATE. CONTACT SALES AGENT FOR MORE INFORMATION. TERMS AND CONDITIONS APPLY. [HTTPS://EGSTOLTZFUSHOMES.COM/TERMS-AND-CONDITIONS/](https://EGSTOLTZFUSHOMES.COM/TERMS-AND-CONDITIONS/)



OPTIONAL EXTENDED COVERED PORCH



TRADITIONAL ELEVATION**



OPTIONAL EXTENDED COVERED PORCH



CLASSIC ELEVATION



OPTIONAL EXTENDED COVERED PORCH



AMERICAN ELEVATION



HERITAGE ELEVATION

ALL IMAGES ARE FOR ARTISTIC PURPOSES ONLY AND MAY CONTAIN ADDITIONAL FEATURES OR DESIGN OPTIONS NOT AVAILABLE ON ALL HOME PLANS AND IN ALL NEIGHBORHOODS. ROOM SIZE DIMENSIONS AND SQUARE FOOTAGES ARE APPROXIMATE. CONTACT SALES AGENT FOR MORE INFORMATION. TERMS AND CONDITIONS APPLY. [HTTPS://EGSTOLTZFUSHOMES.COM/TERMS-AND-CONDITIONS/](https://EGSTOLTZFUSHOMES.COM/TERMS-AND-CONDITIONS/)