







-  = CARPETED AREA
-  = CABLE T.V. ROUGH IN
-  = EXTERIOR RECEPTACLE
-  = RECEPTACLE WITH USB
-  = TELEPHONE OUTLET
-  = EXTERIOR HOSE BIBB



TRADITIONAL** & CLASSIC FLOOR PLAN SHOWN
1st Floor Plan - 1,224 sf
 GLENWOOD

*ISLAND INCLUDED IN SELECT COMMUNITIES AND WITH SELECT KITCHEN PACKAGE OPTIONS
 ** TRADITIONAL FLOOR PLAN ONLY AVAILABLE IN SELECT COMMUNITIES

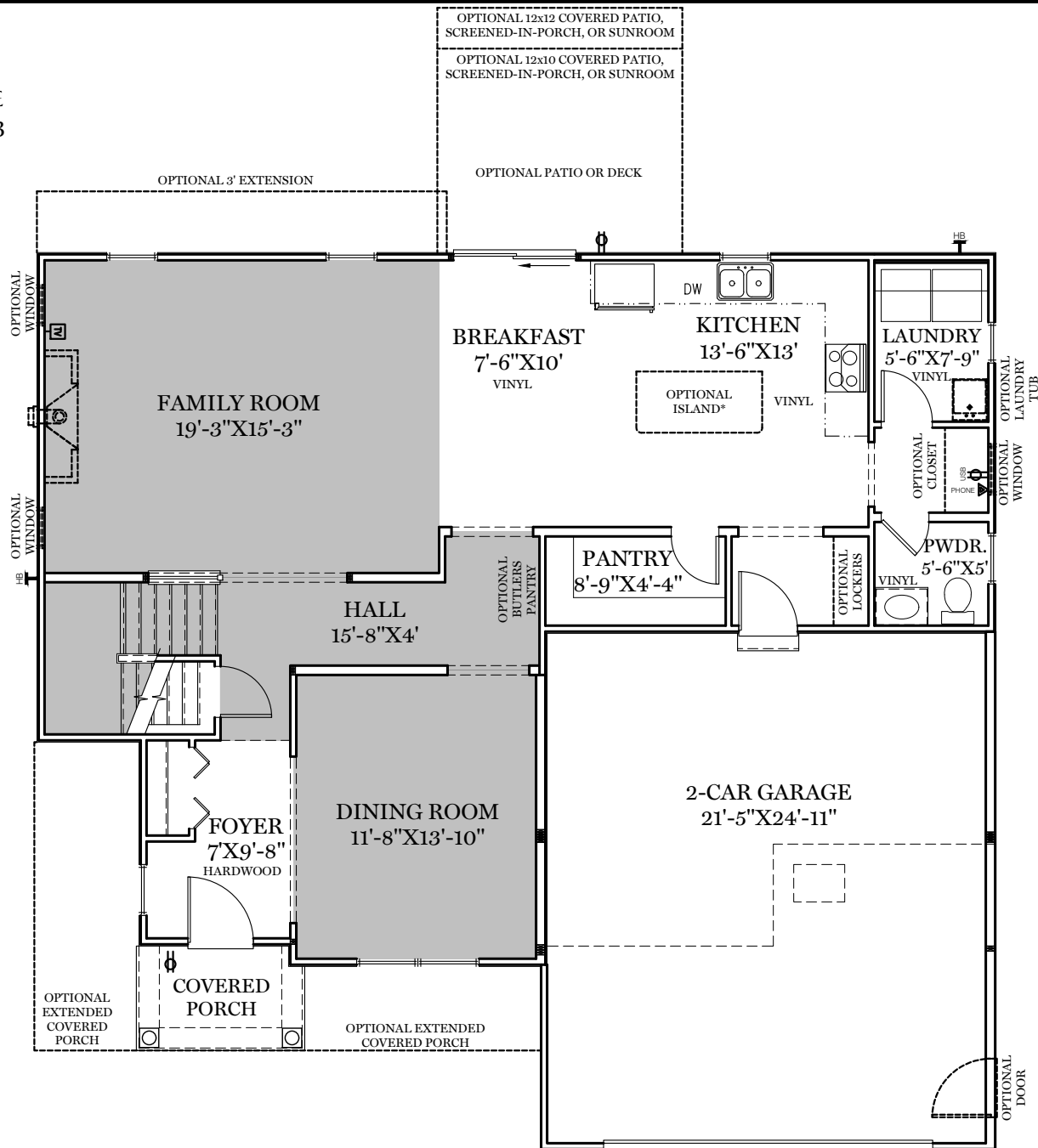
ALL IMAGES ARE FOR ARTISTIC PURPOSES ONLY AND MAY CONTAIN ADDITIONAL FEATURES OR DESIGN OPTIONS NOT AVAILABLE ON ALL HOME PLANS AND IN ALL NEIGHBORHOODS. ROOM SIZE DIMENSIONS AND SQUARE FOOTAGES ARE APPROXIMATE. CONTACT SALES AGENT FOR MORE INFORMATION. TERMS AND CONDITIONS APPLY. [HTTPS://EGSTOLTZFUSHOMES.COM/TERMS-AND-CONDITIONS/](https://EGSTOLTZFUSHOMES.COM/TERMS-AND-CONDITIONS/)

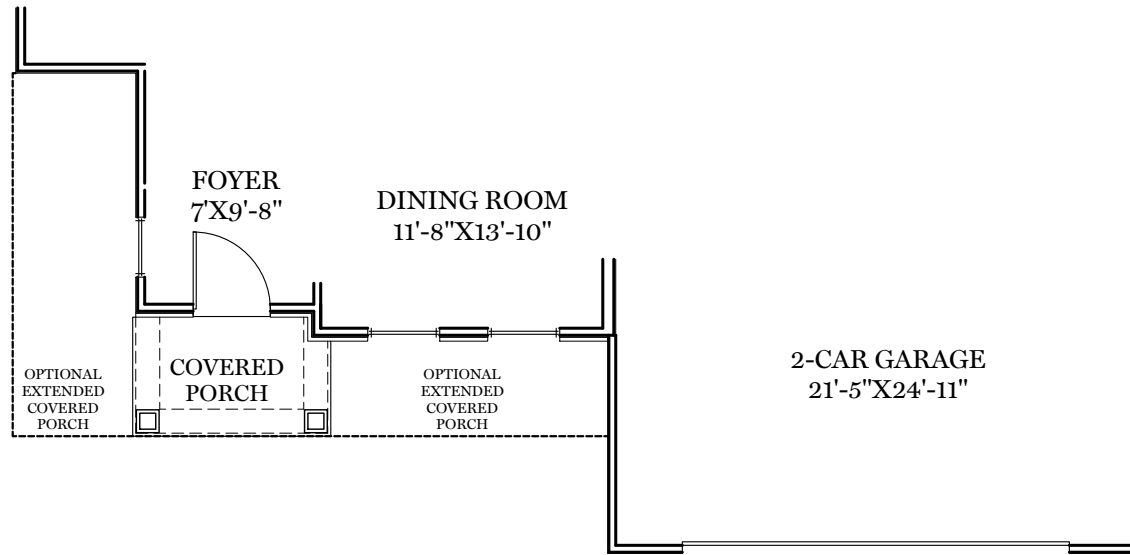

AMERICAN FLOOR PLAN

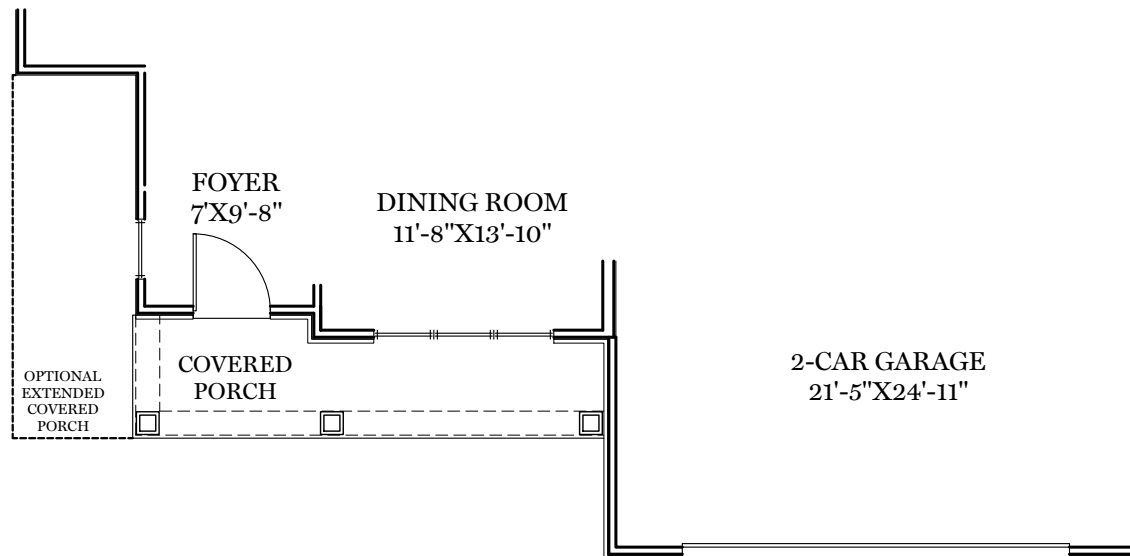

HERITAGE FLOOR PLAN

1st Floor Plan

GLENWOOD

ALL IMAGES ARE FOR ARTISTIC PURPOSES ONLY AND MAY CONTAIN ADDITIONAL FEATURES OR DESIGN OPTIONS NOT AVAILABLE ON ALL HOME PLANS AND IN ALL NEIGHBORHOODS. ROOM SIZE DIMENSIONS AND SQUARE FOOTAGES ARE APPROXIMATE. CONTACT SALES AGENT FOR MORE INFORMATION. TERMS AND CONDITIONS APPLY. [HTTPS://EGSTOLTZFUSHOMES.COM/TERMS-AND-CONDITIONS/](https://EGSTOLTZFUSHOMES.COM/TERMS-AND-CONDITIONS/)

PDF LAST UPDATED 1/14/2022

- = CARPETED AREA
- TV = CABLE T.V. ROUGH IN

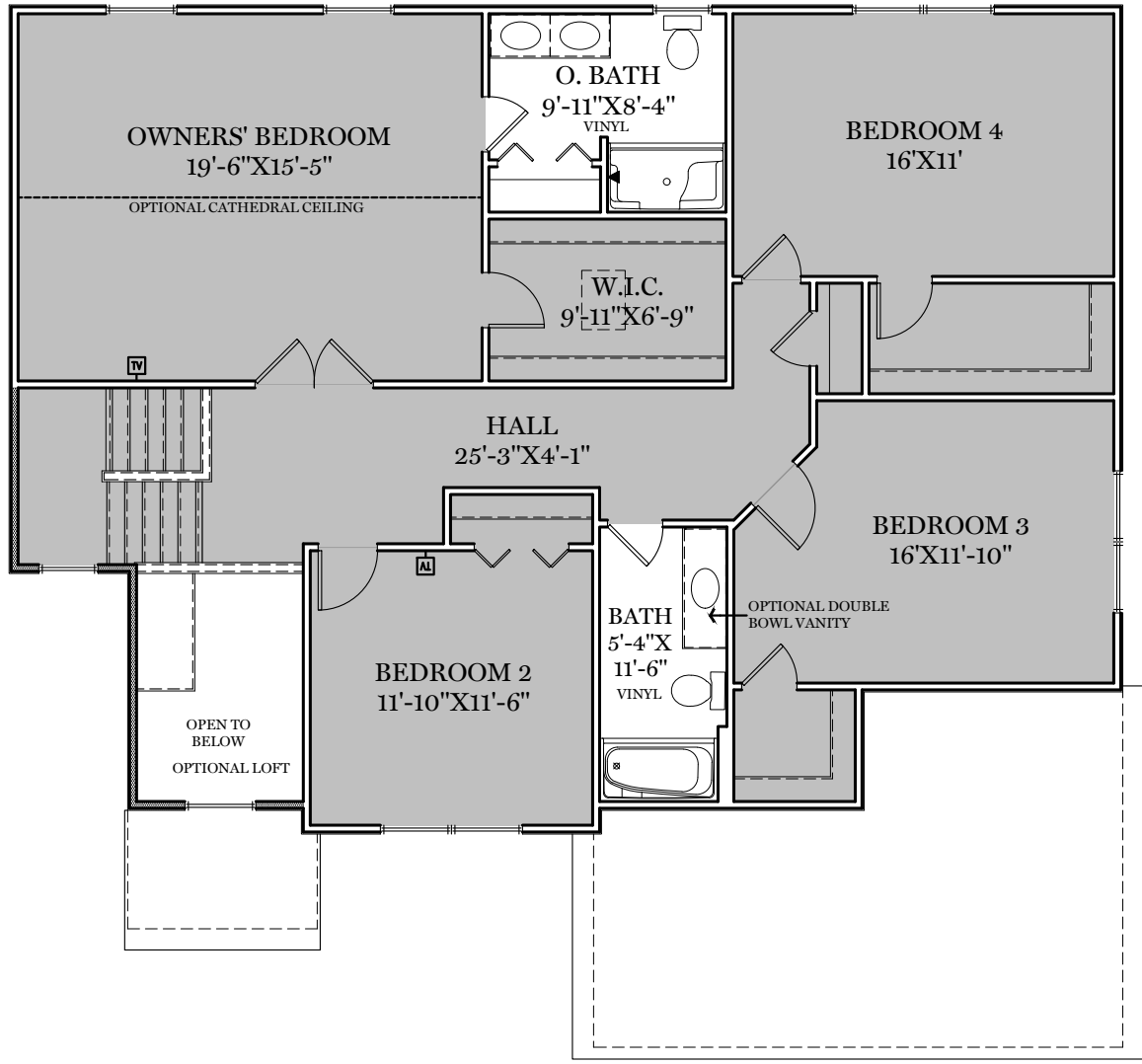

ALL IMAGES ARE FOR ARTISTIC PURPOSES ONLY AND MAY CONTAIN ADDITIONAL FEATURES OR DESIGN OPTIONS NOT AVAILABLE ON ALL HOME PLANS AND IN ALL NEIGHBORHOODS. ROOM SIZE DIMENSIONS AND SQUARE FOOTAGES ARE APPROXIMATE. CONTACT SALES AGENT FOR MORE INFORMATION. TERMS AND CONDITIONS APPLY. [HTTPS://EGSTOLTZFUSHOMES.COM/TERMS-AND-CONDITIONS/](https://EGSTOLTZFUSHOMES.COM/TERMS-AND-CONDITIONS/)

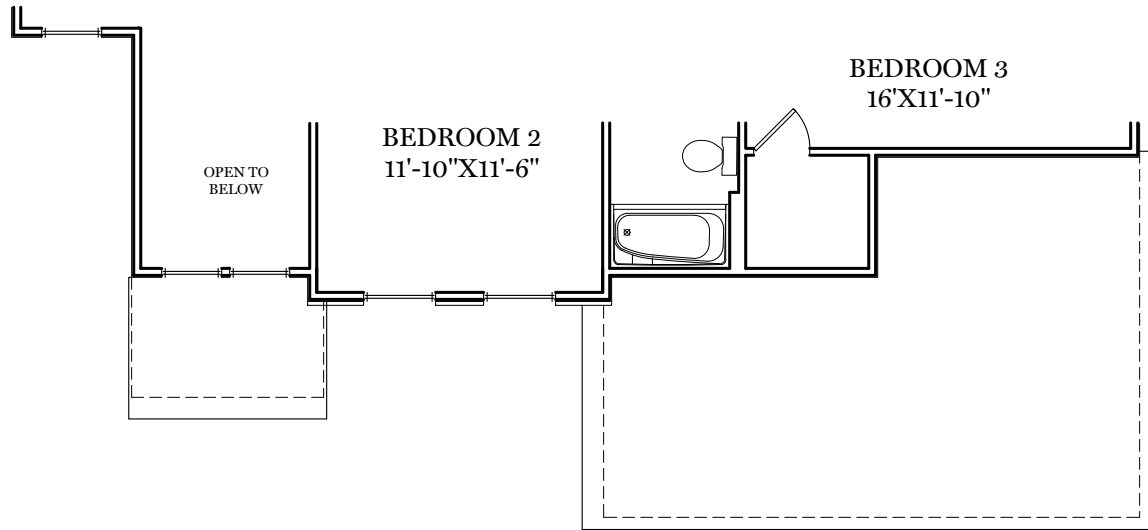

AMERICAN FLOOR PLAN

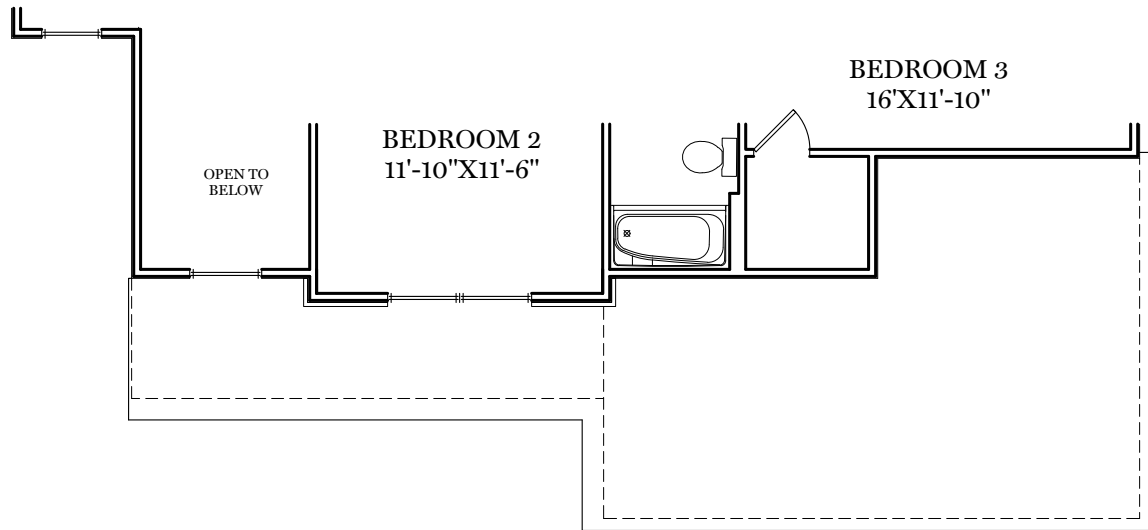

HERITAGE FLOOR PLAN

ALL IMAGES ARE FOR ARTISTIC PURPOSES ONLY AND MAY CONTAIN ADDITIONAL FEATURES OR DESIGN OPTIONS NOT AVAILABLE ON ALL HOME PLANS AND IN ALL NEIGHBORHOODS. ROOM SIZE DIMENSIONS AND SQUARE FOOTAGES ARE APPROXIMATE. CONTACT SALES AGENT FOR MORE INFORMATION. TERMS AND CONDITIONS APPLY. [HTTPS://EGSTOLTZFUSHOMES.COM/TERMS-AND-CONDITIONS/](https://EGSTOLTZFUSHOMES.COM/TERMS-AND-CONDITIONS/)

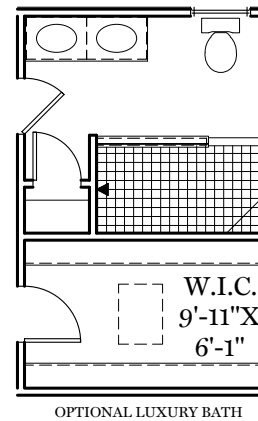
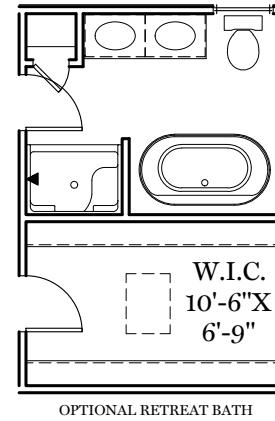
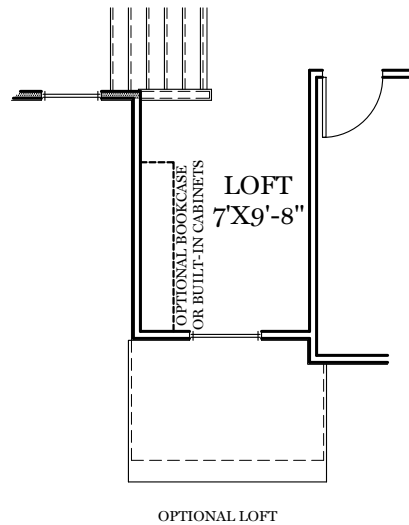
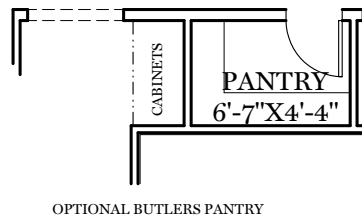
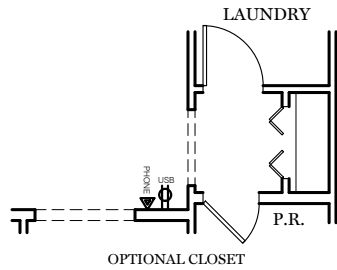

ALL IMAGES ARE FOR ARTISTIC PURPOSES ONLY AND MAY CONTAIN ADDITIONAL FEATURES OR DESIGN OPTIONS NOT AVAILABLE ON ALL HOME PLANS AND IN ALL NEIGHBORHOODS. ROOM SIZE DIMENSIONS AND SQUARE FOOTAGES ARE APPROXIMATE. CONTACT SALES AGENT FOR MORE INFORMATION. TERMS AND CONDITIONS APPLY. [HTTPS://EGSTOLTZFUSHOMES.COM/TERMS-AND-CONDITIONS/](https://EGSTOLTZFUSHOMES.COM/TERMS-AND-CONDITIONS/)

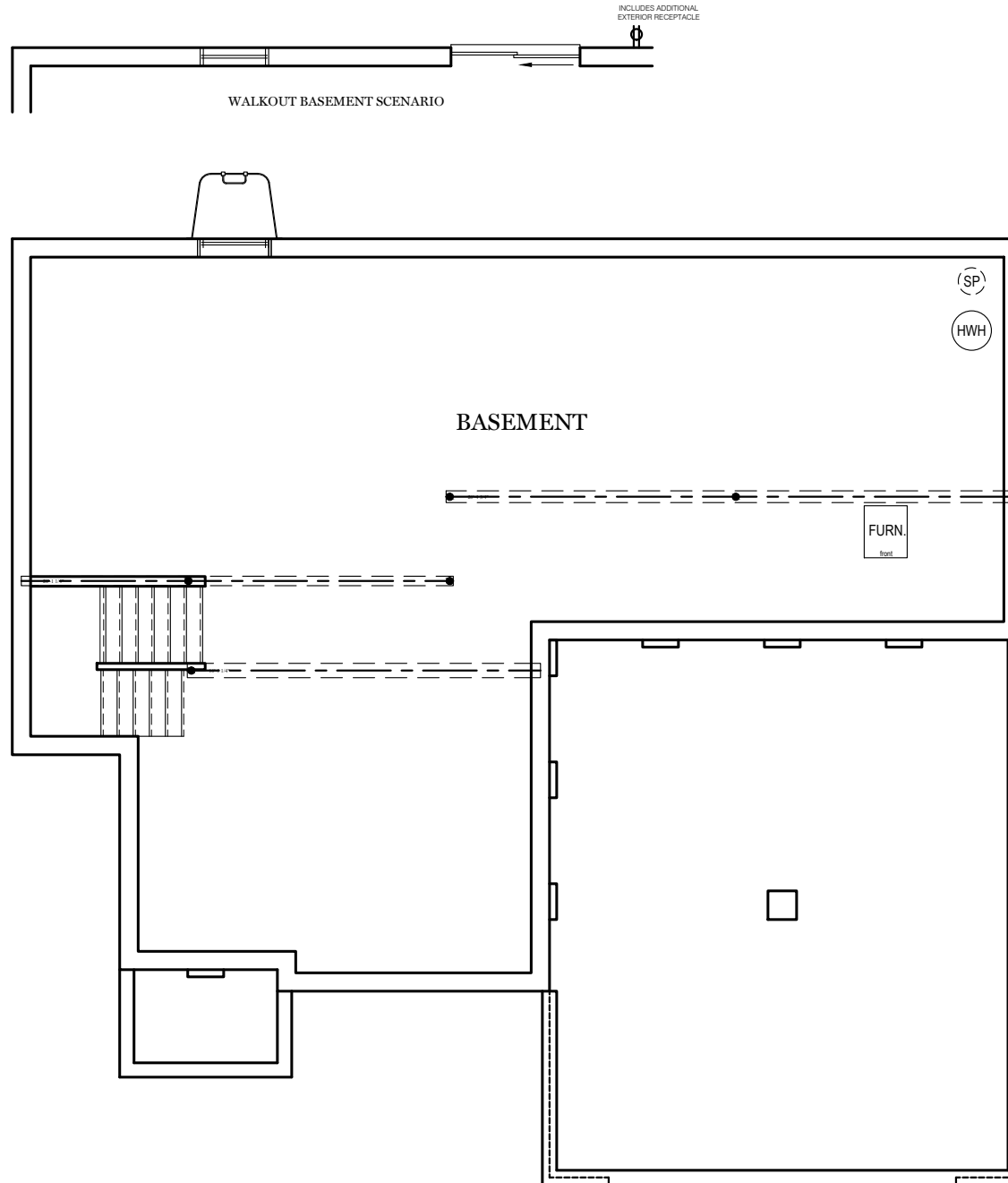

E.G.S. RESERVES THE RIGHT TO RELOCATE MECHANICALS AS REQ. BY SITE CONDITIONS

ALL IMAGES ARE FOR ARTISTIC PURPOSES ONLY AND MAY CONTAIN ADDITIONAL FEATURES OR DESIGN OPTIONS NOT AVAILABLE ON ALL HOME PLANS AND IN ALL NEIGHBORHOODS. ROOM SIZE DIMENSIONS AND SQUARE FOOTAGES ARE APPROXIMATE. CONTACT SALES AGENT FOR MORE INFORMATION. TERMS AND CONDITIONS APPLY. [HTTPS://EGSTOLTZFUSHOMES.COM/TERMS-AND-CONDITIONS/](https://EGSTOLTZFUSHOMES.COM/TERMS-AND-CONDITIONS/)

** TRADITIONAL FLOOR PLAN ONLY AVAILABLE IN SELECT COMMUNITIES

PDF LAST UPDATED 1/14/2022

■ = CARPETED AREA

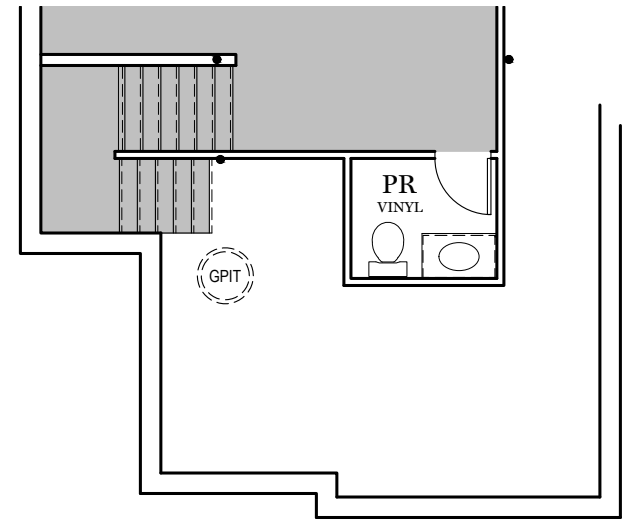
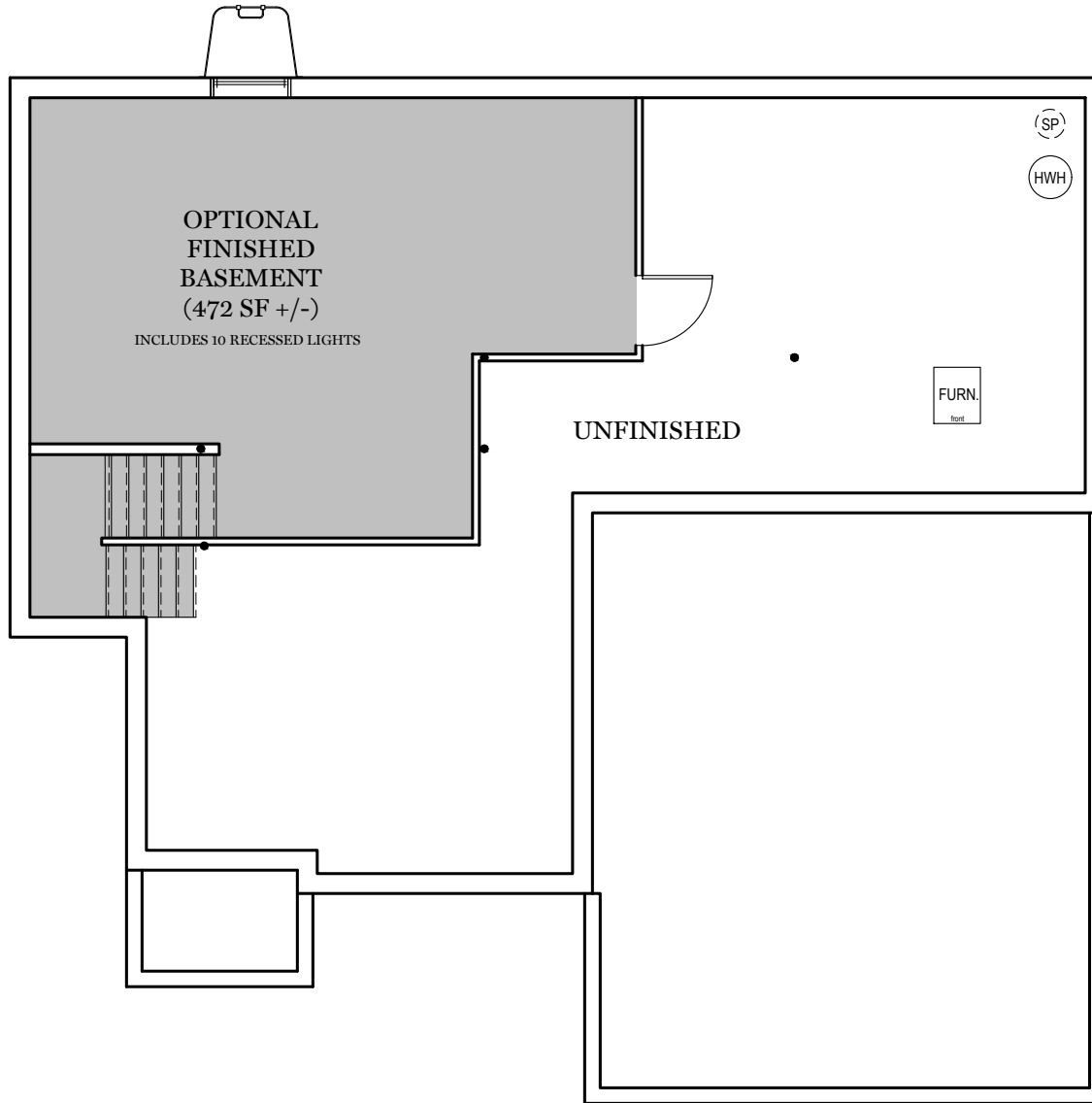

OPTIONAL FINISHED POWDER ROOM (+36 SF)

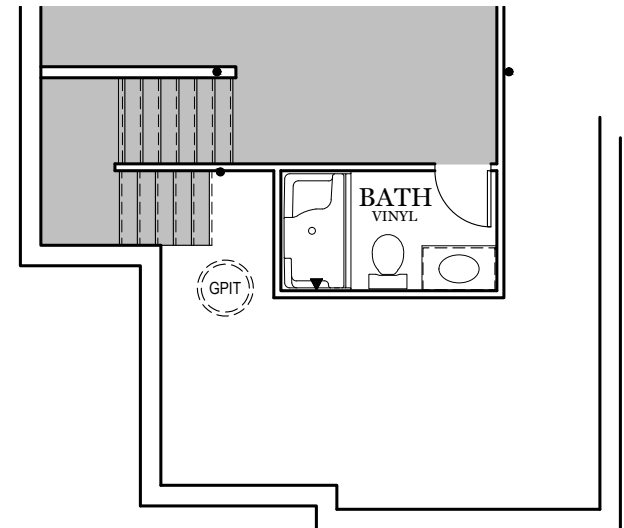

OPTIONAL FINISHED BATHROOM (+51 SF)

ALL IMAGES ARE FOR ARTISTIC PURPOSES ONLY AND MAY CONTAIN ADDITIONAL FEATURES OR DESIGN OPTIONS NOT AVAILABLE ON ALL HOME PLANS AND IN ALL NEIGHBORHOODS. ROOM SIZE DIMENSIONS AND SQUARE FOOTAGES ARE APPROXIMATE. CONTACT SALES AGENT FOR MORE INFORMATION. TERMS AND CONDITIONS APPLY. [HTTPS://EGSTOLTZFUSHOMES.COM/TERMS-AND-CONDITIONS/](https://EGSTOLTZFUSHOMES.COM/TERMS-AND-CONDITIONS/)



OPTIONAL EXTENDED COVERED PORCH



TRADITIONAL ELEVATION**



OPTIONAL EXTENDED COVERED PORCH



CLASSIC ELEVATION

ALL IMAGES ARE FOR ARTISTIC PURPOSES ONLY AND MAY CONTAIN ADDITIONAL FEATURES OR DESIGN OPTIONS NOT AVAILABLE ON ALL HOME PLANS AND IN ALL NEIGHBORHOODS. ROOM SIZE DIMENSIONS AND SQUARE FOOTAGES ARE APPROXIMATE. CONTACT SALES AGENT FOR MORE INFORMATION. TERMS AND CONDITIONS APPLY. [HTTPS://EGSTOLTZFUSHOMES.COM/TERMS-AND-CONDITIONS/](https://egstoltzfushomes.com/terms-and-conditions/)

** TRADITIONAL ELEVATION ONLY AVAILABLE IN SELECT COMMUNITIES

PDF LAST UPDATED 1/14/2022



OPTIONAL EXTENDED COVERED PORCH



AMERICAN ELEVATION



OPTIONAL EXTENDED COVERED PORCH



HERITAGE ELEVATION

ALL IMAGES ARE FOR ARTISTIC PURPOSES ONLY AND MAY CONTAIN ADDITIONAL FEATURES OR DESIGN OPTIONS NOT AVAILABLE ON ALL HOME PLANS AND IN ALL NEIGHBORHOODS. ROOM SIZE DIMENSIONS AND SQUARE FOOTAGES ARE APPROXIMATE. CONTACT SALES AGENT FOR MORE INFORMATION. TERMS AND CONDITIONS APPLY. [HTTPS://EGSTOLTZFUSHOMES.COM/TERMS-AND-CONDITIONS/](https://EGSTOLTZFUSHOMES.COM/TERMS-AND-CONDITIONS/)