

- = CARPETED AREA
- ⊕ = EXTERIOR RECEPTACLE
- HB ⊕ = EXTERIOR HOSE BIBB
- ⊕ = FLUSH MOUNT RECESSED-STYLE LIGHT
- ⊙ = CEILING LIGHT

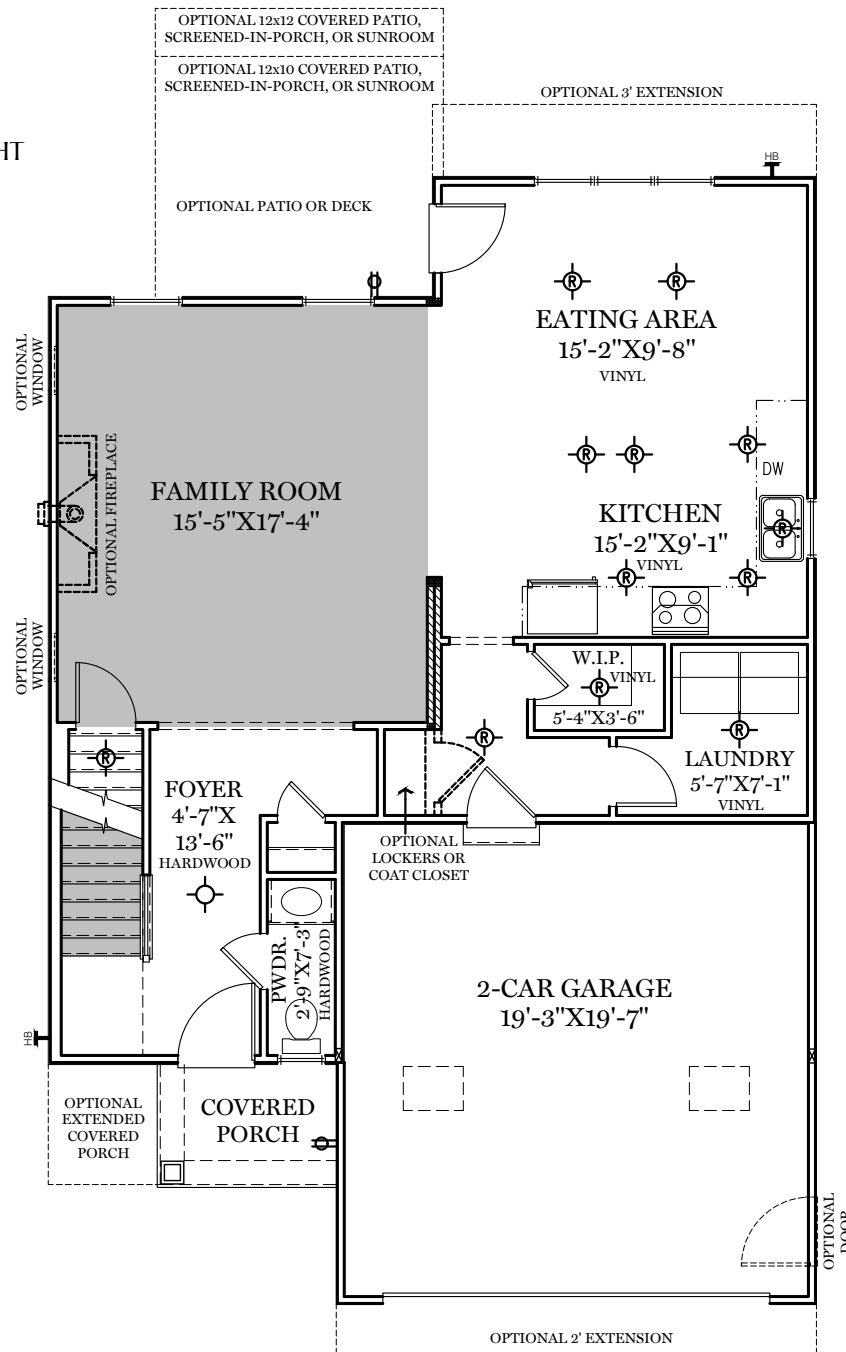

TRADITIONAL\*\*, CLASSIC, & AMERICAN FLOOR PLAN SHOWN

# 1st Floor Plan - 908 sf

JAMESON

\*\* TRADITIONAL FLOOR PLAN ONLY AVAILABLE IN SELECT COMMUNITIES

ALL IMAGES ARE FOR ARTISTIC PURPOSES ONLY AND MAY CONTAIN ADDITIONAL FEATURES OR DESIGN OPTIONS NOT AVAILABLE ON ALL HOME PLANS AND IN ALL NEIGHBORHOODS. ROOM SIZE DIMENSIONS AND SQUARE FOOTAGES ARE APPROXIMATE. CONTACT SALES AGENT FOR MORE INFORMATION. TERMS AND CONDITIONS APPLY. [HTTPS://EGSTOLTZFUSHOMES.COM/TERMS-AND-CONDITIONS/](https://EGSTOLTZFUSHOMES.COM/TERMS-AND-CONDITIONS/)

PDF LAST UPDATED 2/20/2023

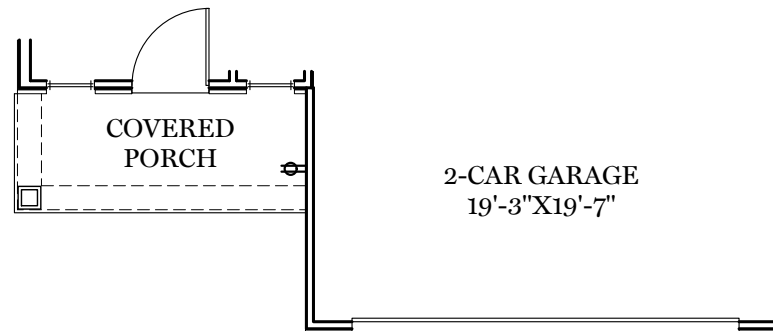

HERITAGE FLOOR PLAN

# 1st Floor Plan

JAMESON

■ = CARPETED AREA

⊗ = FLUSH MOUNT RECESSED-STYLE LIGHT

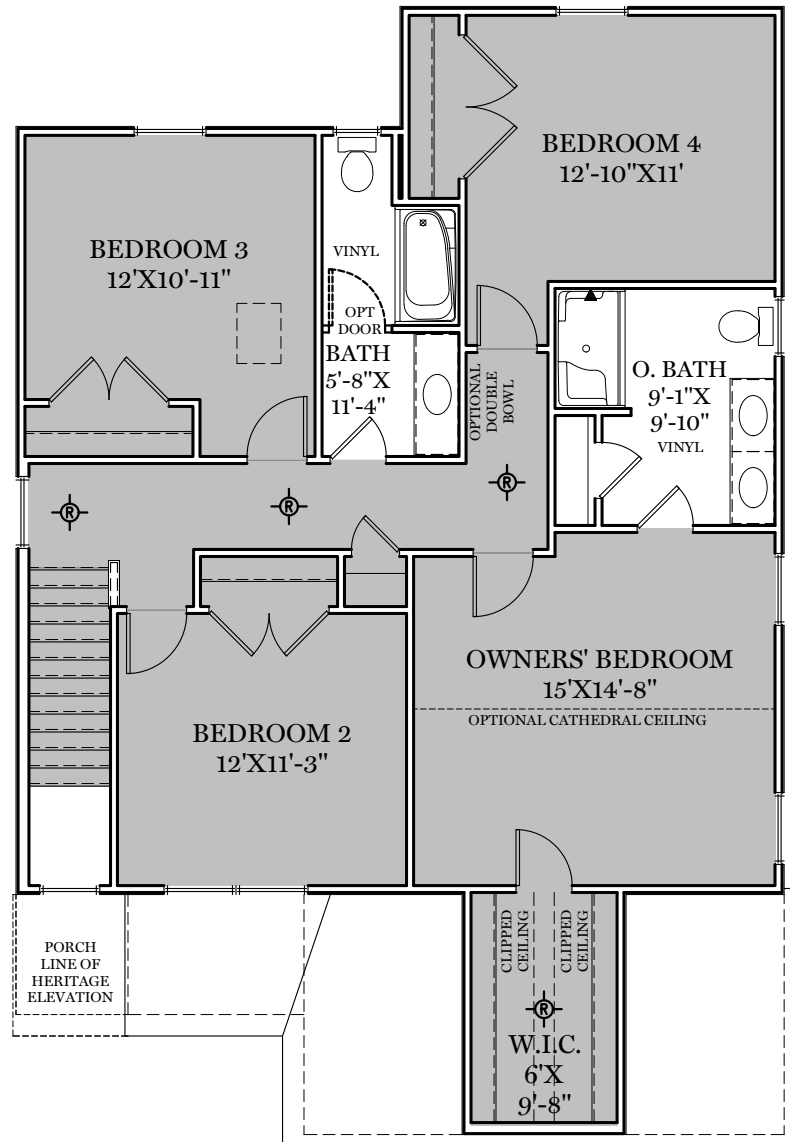

TRADITIONAL\*\*, CLASSIC, & AMERICAN FLOOR PLAN SHOWN

## 2nd Floor Plan - 1,173 sf

JAMESON

\*\* TRADITIONAL FLOOR PLAN ONLY AVAILABLE IN SELECT COMMUNITIES

ALL IMAGES ARE FOR ARTISTIC PURPOSES ONLY AND MAY CONTAIN ADDITIONAL FEATURES OR DESIGN OPTIONS NOT AVAILABLE ON ALL HOME PLANS AND IN ALL NEIGHBORHOODS. ROOM SIZE DIMENSIONS AND SQUARE FOOTAGES ARE APPROXIMATE. CONTACT SALES AGENT FOR MORE INFORMATION. TERMS AND CONDITIONS APPLY. [HTTPS://EGSTOLTZFUSHOMES.COM/TERMS-AND-CONDITIONS/](https://EGSTOLTZFUSHOMES.COM/TERMS-AND-CONDITIONS/)

PDF LAST UPDATED 2/20/2023

⊗ = FLUSH MOUNT RECESSED-STYLE LIGHT

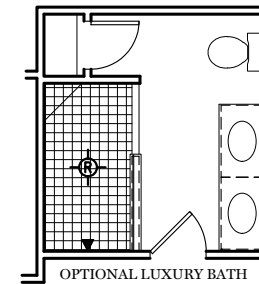
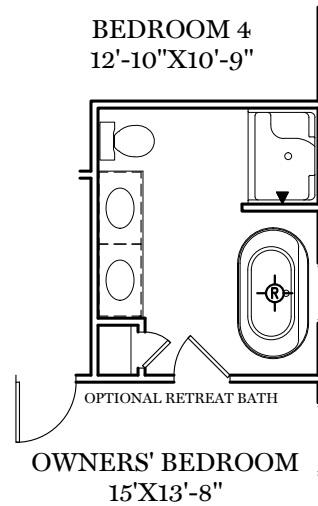
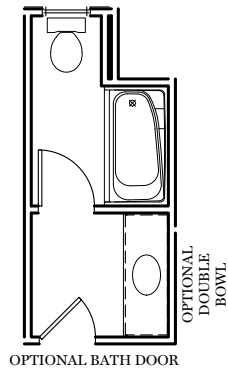

ALL IMAGES ARE FOR ARTISTIC PURPOSES ONLY AND MAY CONTAIN ADDITIONAL FEATURES OR DESIGN OPTIONS NOT AVAILABLE ON ALL HOME PLANS AND IN ALL NEIGHBORHOODS. ROOM SIZE DIMENSIONS AND SQUARE FOOTAGES ARE APPROXIMATE. CONTACT SALES AGENT FOR MORE INFORMATION. TERMS AND CONDITIONS APPLY. [HTTPS://EGSTOLTZFUSHOMES.COM/TERMS-AND-CONDITIONS/](https://egstoltzfushomes.com/terms-and-conditions/)

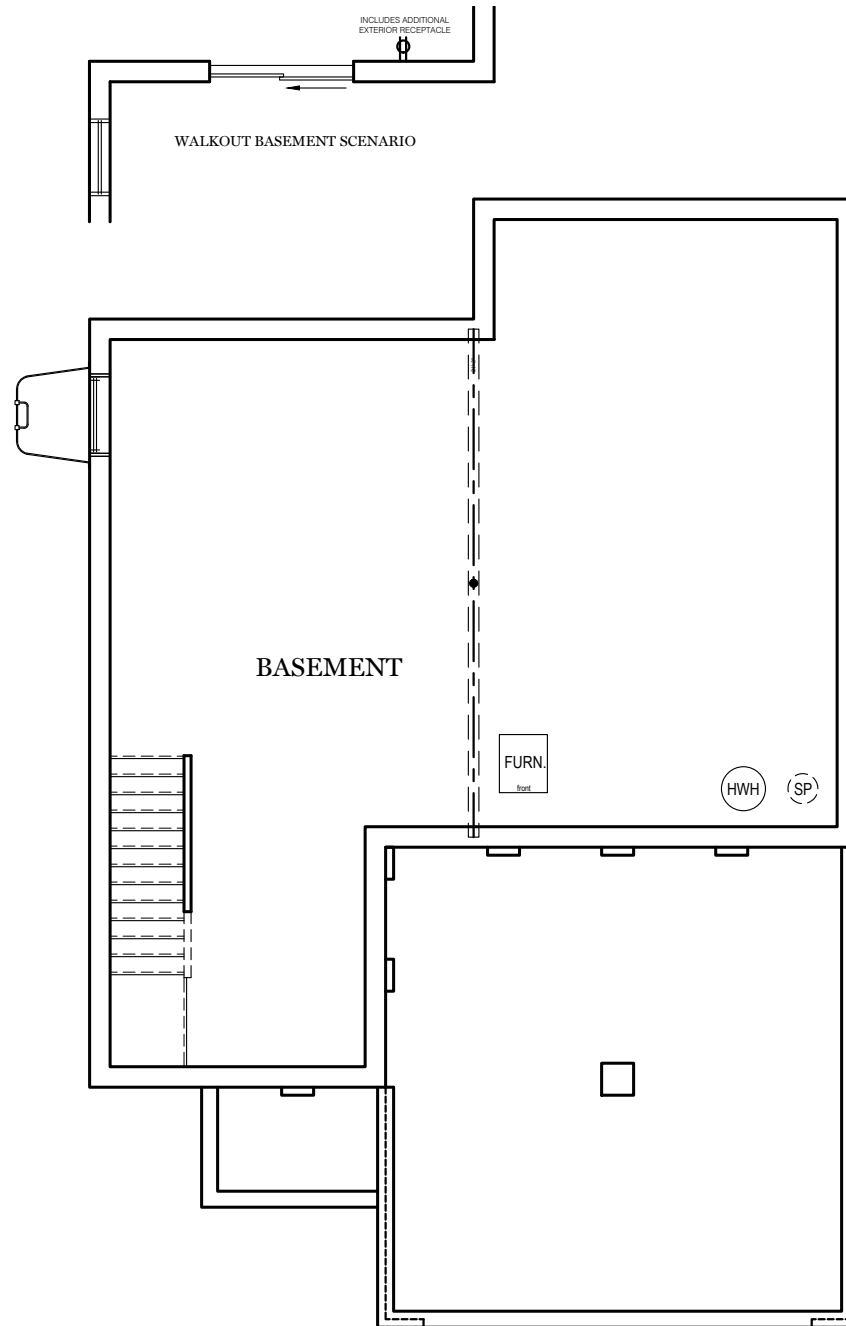

TRADITIONAL\*\* FLOOR PLAN SHOWN

# Foundation

JAMESON

\*\* TRADITIONAL FLOOR PLAN ONLY AVAILABLE IN SELECT COMMUNITIES

E.G.S. RESERVES THE RIGHT TO RELOCATE MECHANICALS AS REQ. BY SITE CONDITIONS

ALL IMAGES ARE FOR ARTISTIC PURPOSES ONLY AND MAY CONTAIN ADDITIONAL FEATURES OR DESIGN OPTIONS NOT AVAILABLE ON ALL HOME PLANS AND IN ALL NEIGHBORHOODS. ROOM SIZE DIMENSIONS AND SQUARE FOOTAGES ARE APPROXIMATE. CONTACT SALES AGENT FOR MORE INFORMATION. TERMS AND CONDITIONS APPLY. [HTTPS://EGSTOLTZFUSHOMES.COM/TERMS-AND-CONDITIONS/](https://EGSTOLTZFUSHOMES.COM/TERMS-AND-CONDITIONS/)

PDF LAST UPDATED 2/20/2023

■ = CARPETED AREA

⊗ = FLUSH MOUNT RECESSED-STYLE LIGHT

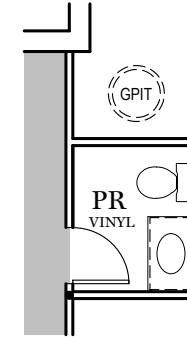
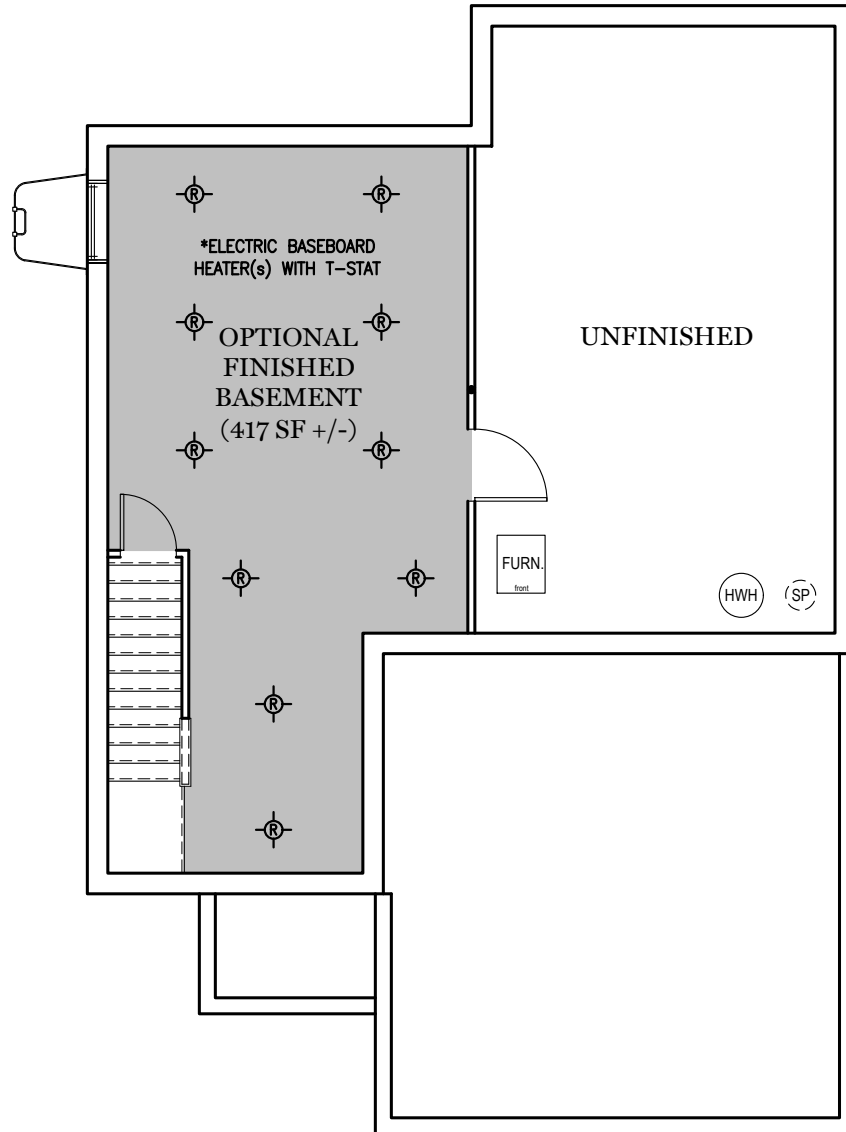

OPTIONAL FINISHED POWDER ROOM (+35 SF)

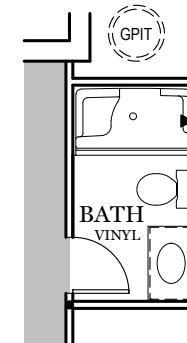

OPTIONAL FINISHED BATHROOM (+51 SF)

ALL IMAGES ARE FOR ARTISTIC PURPOSES ONLY AND MAY CONTAIN ADDITIONAL FEATURES OR DESIGN OPTIONS NOT AVAILABLE ON ALL HOME PLANS AND IN ALL NEIGHBORHOODS. ROOM SIZE DIMENSIONS AND SQUARE FOOTAGES ARE APPROXIMATE. CONTACT SALES AGENT FOR MORE INFORMATION. TERMS AND CONDITIONS APPLY. [HTTPS://EGSTOLTZFUSHOMES.COM/TERMS-AND-CONDITIONS/](https://EGSTOLTZFUSHOMES.COM/TERMS-AND-CONDITIONS/)



OPTIONAL EXTENDED COVERED PORCH



TRADITIONAL ELEVATION\*\*



OPTIONAL EXTENDED COVERED PORCH



CLASSIC ELEVATION



OPTIONAL EXTENDED COVERED PORCH



AMERICAN ELEVATION



HERITAGE ELEVATION

## Elevations

JAMESON

ALL IMAGES ARE FOR ARTISTIC PURPOSES ONLY AND MAY CONTAIN ADDITIONAL FEATURES OR DESIGN OPTIONS NOT AVAILABLE ON ALL HOME PLANS AND IN ALL NEIGHBORHOODS. ROOM SIZE DIMENSIONS AND SQUARE FOOTAGES ARE APPROXIMATE. CONTACT SALES AGENT FOR MORE INFORMATION. TERMS AND CONDITIONS APPLY. [HTTPS://EGSTOLTZFUSHOMES.COM/TERMS-AND-CONDITIONS/](https://EGSTOLTZFUSHOMES.COM/TERMS-AND-CONDITIONS/)