

- = CARPETED AREA
- ⊕ = EXTERIOR RECEPTACLE
- HB
| = EXTERIOR HOSE BIBB
- ⊙ = FLUSH MOUNT RECESSED-STYLE LIGHT
- ⊙ = CEILING LIGHT

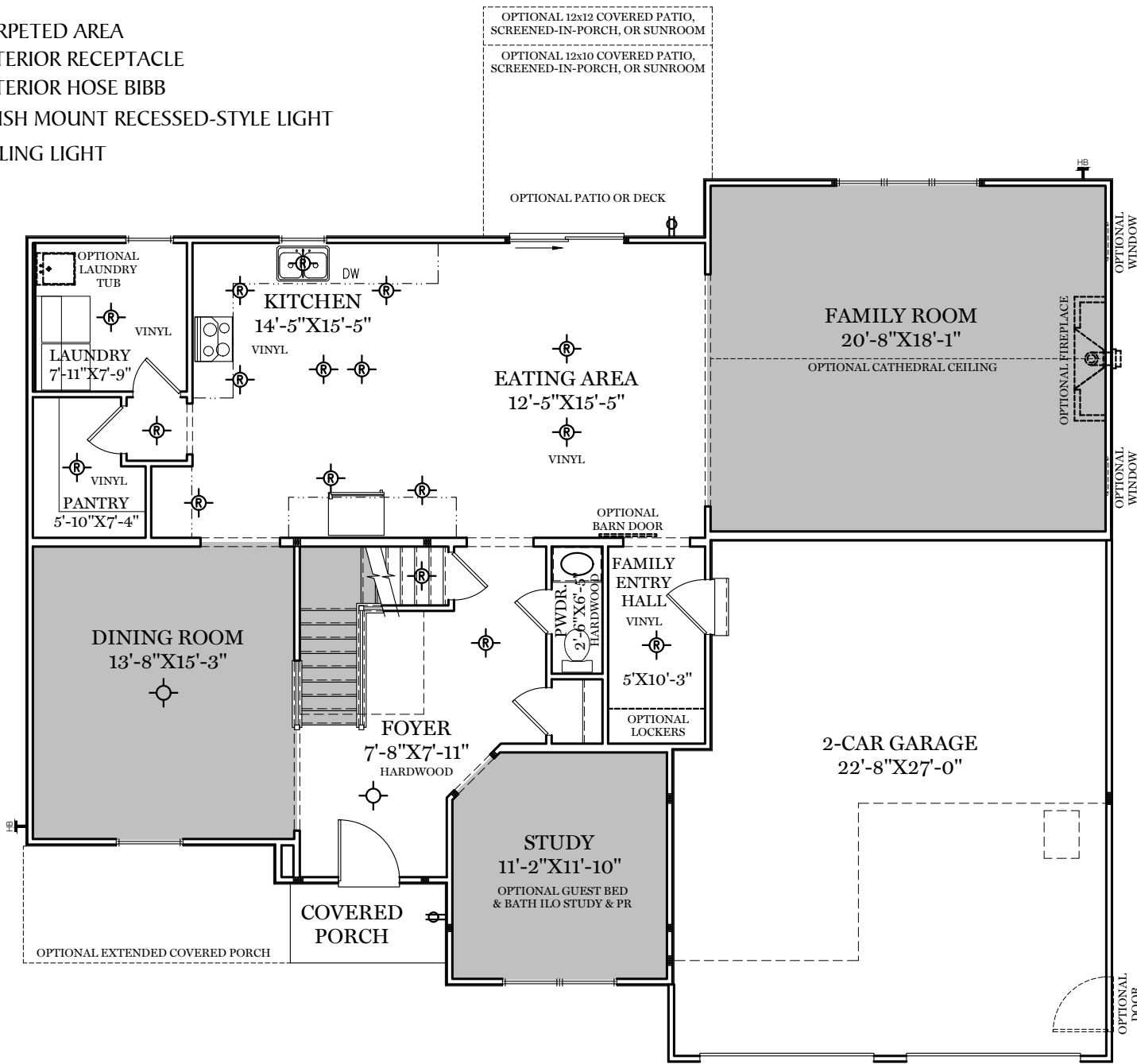

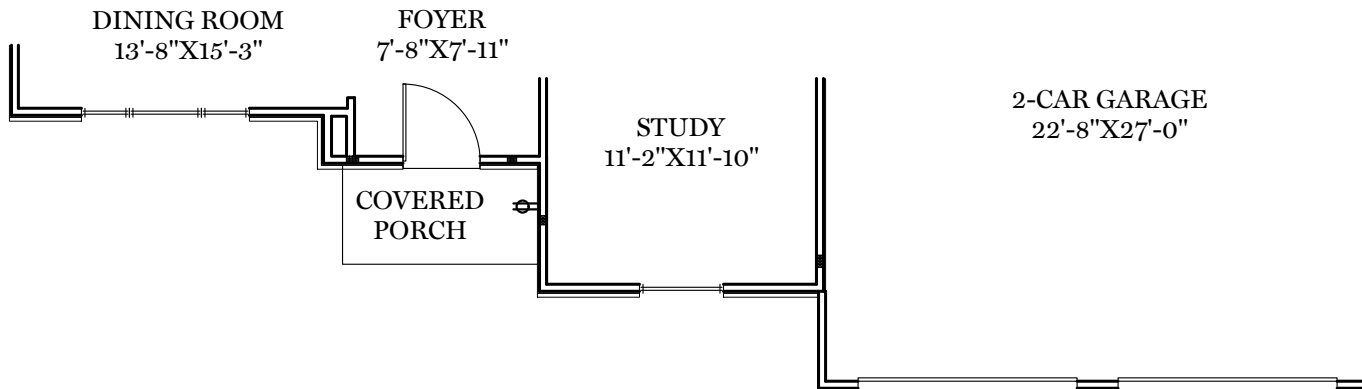

AMERICAN FLOOR PLAN

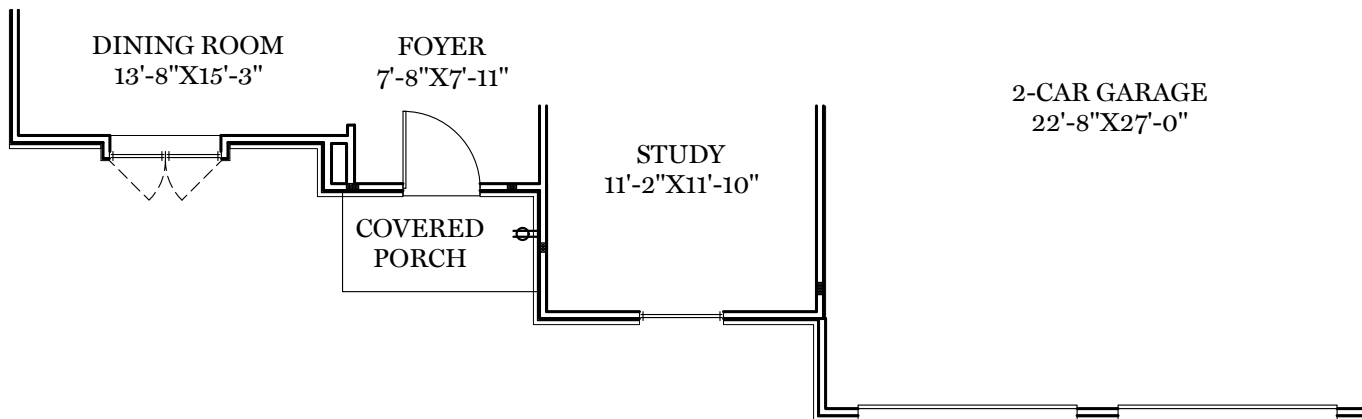

HERITAGE FLOOR PLAN

ALL IMAGES ARE FOR ARTISTIC PURPOSES ONLY AND MAY CONTAIN ADDITIONAL FEATURES OR DESIGN OPTIONS NOT AVAILABLE ON ALL HOME PLANS AND IN ALL NEIGHBORHOODS. ROOM SIZE DIMENSIONS AND SQUARE FOOTAGES ARE APPROXIMATE. CONTACT SALES AGENT FOR MORE INFORMATION. TERMS AND CONDITIONS APPLY. [HTTPS://EGSTOLTZFUSHOMES.COM/TERMS-AND-CONDITIONS/](https://EGSTOLTZFUSHOMES.COM/TERMS-AND-CONDITIONS/)

■ = CARPETED AREA

⊙ = FLUSH MOUNT RECESSED-STYLE LIGHT

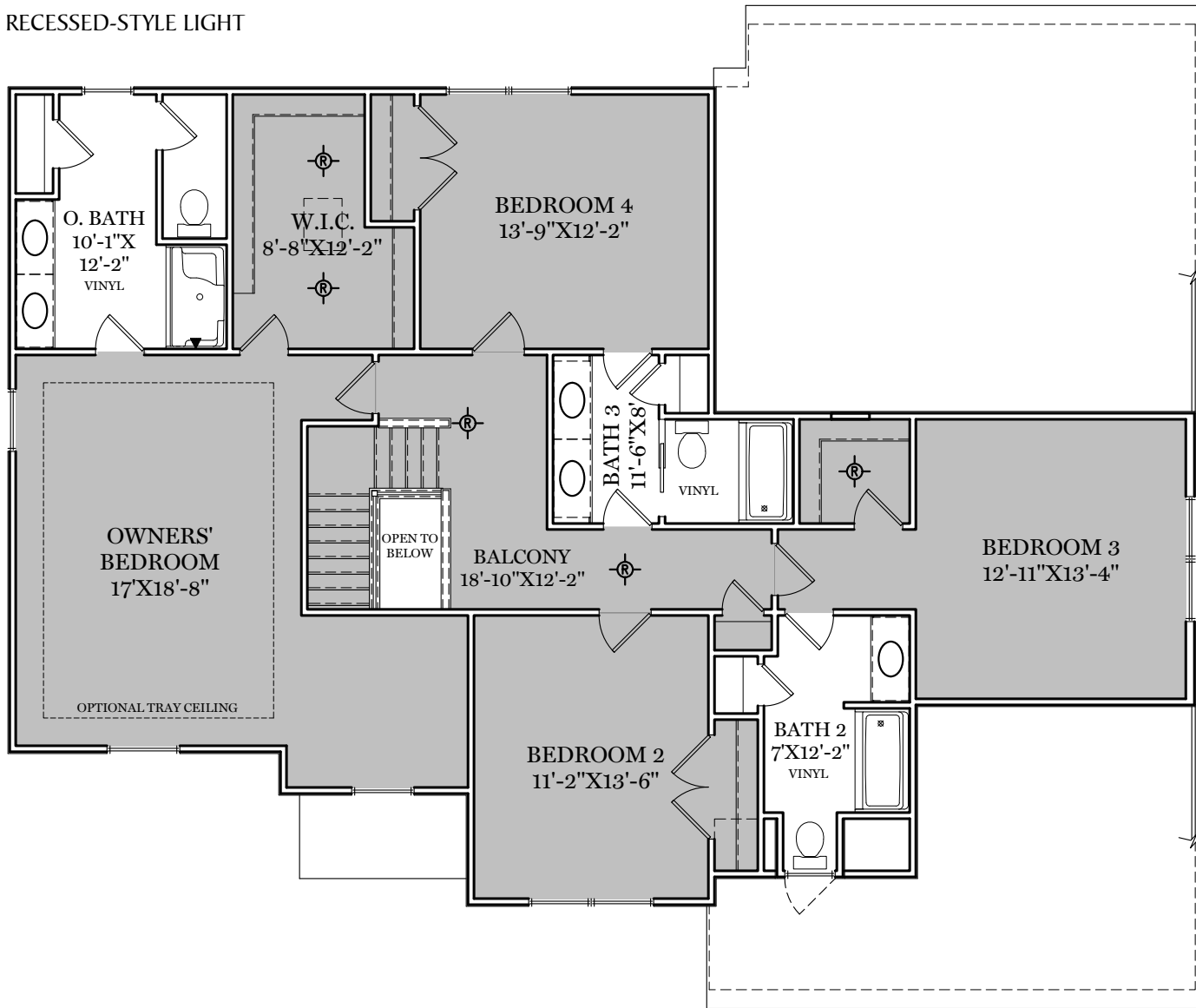

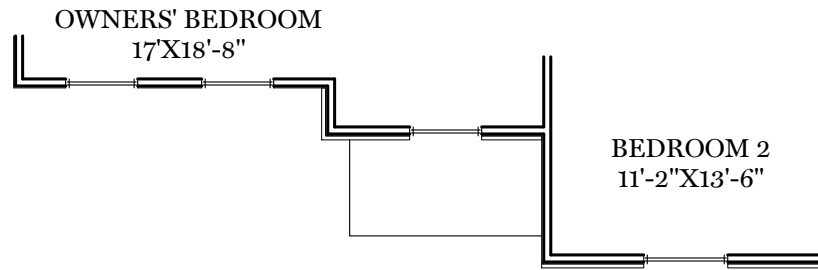

AMERICAN FLOOR PLAN

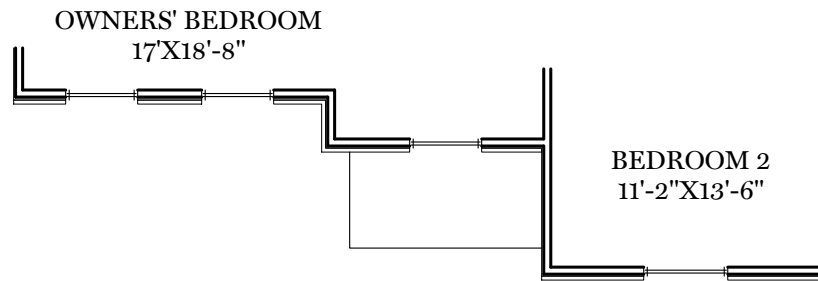

HERITAGE FLOOR PLAN

ALL IMAGES ARE FOR ARTISTIC PURPOSES ONLY AND MAY CONTAIN ADDITIONAL FEATURES OR DESIGN OPTIONS NOT AVAILABLE ON ALL HOME PLANS AND IN ALL NEIGHBORHOODS. ROOM SIZE DIMENSIONS AND SQUARE FOOTAGES ARE APPROXIMATE. CONTACT SALES AGENT FOR MORE INFORMATION. TERMS AND CONDITIONS APPLY. [HTTPS://EGSTOLTZFUSHOMES.COM/TERMS-AND-CONDITIONS/](https://EGSTOLTZFUSHOMES.COM/TERMS-AND-CONDITIONS/)

⊗ = FLUSH MOUNT RECESSED-STYLE LIGHT

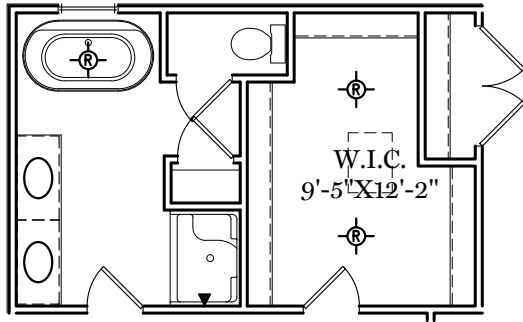

OPTIONAL RETREAT BATH

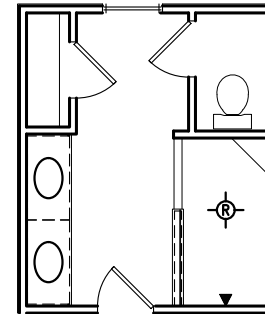

OPTIONAL LUXURY BATH

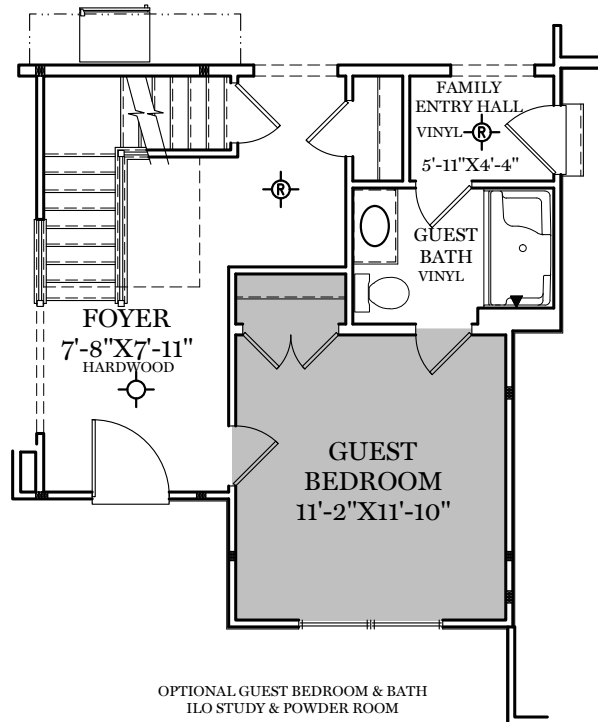

OPTIONAL GUEST BEDROOM & BATH
ILO STUDY & POWDER ROOM

ALL IMAGES ARE FOR ARTISTIC PURPOSES ONLY AND MAY CONTAIN ADDITIONAL FEATURES OR DESIGN OPTIONS NOT AVAILABLE ON ALL HOME PLANS AND IN ALL NEIGHBORHOODS. ROOM SIZE DIMENSIONS AND SQUARE FOOTAGES ARE APPROXIMATE. CONTACT SALES AGENT FOR MORE INFORMATION. TERMS AND CONDITIONS APPLY. [HTTPS://EGSTOLTZFUSHOMES.COM/TERMS-AND-CONDITIONS/](https://EGSTOLTZFUSHOMES.COM/TERMS-AND-CONDITIONS/)

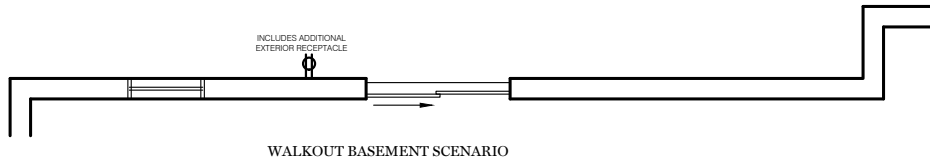

⊗ = FLUSH MOUNT RECESSED-STYLE LIGHT

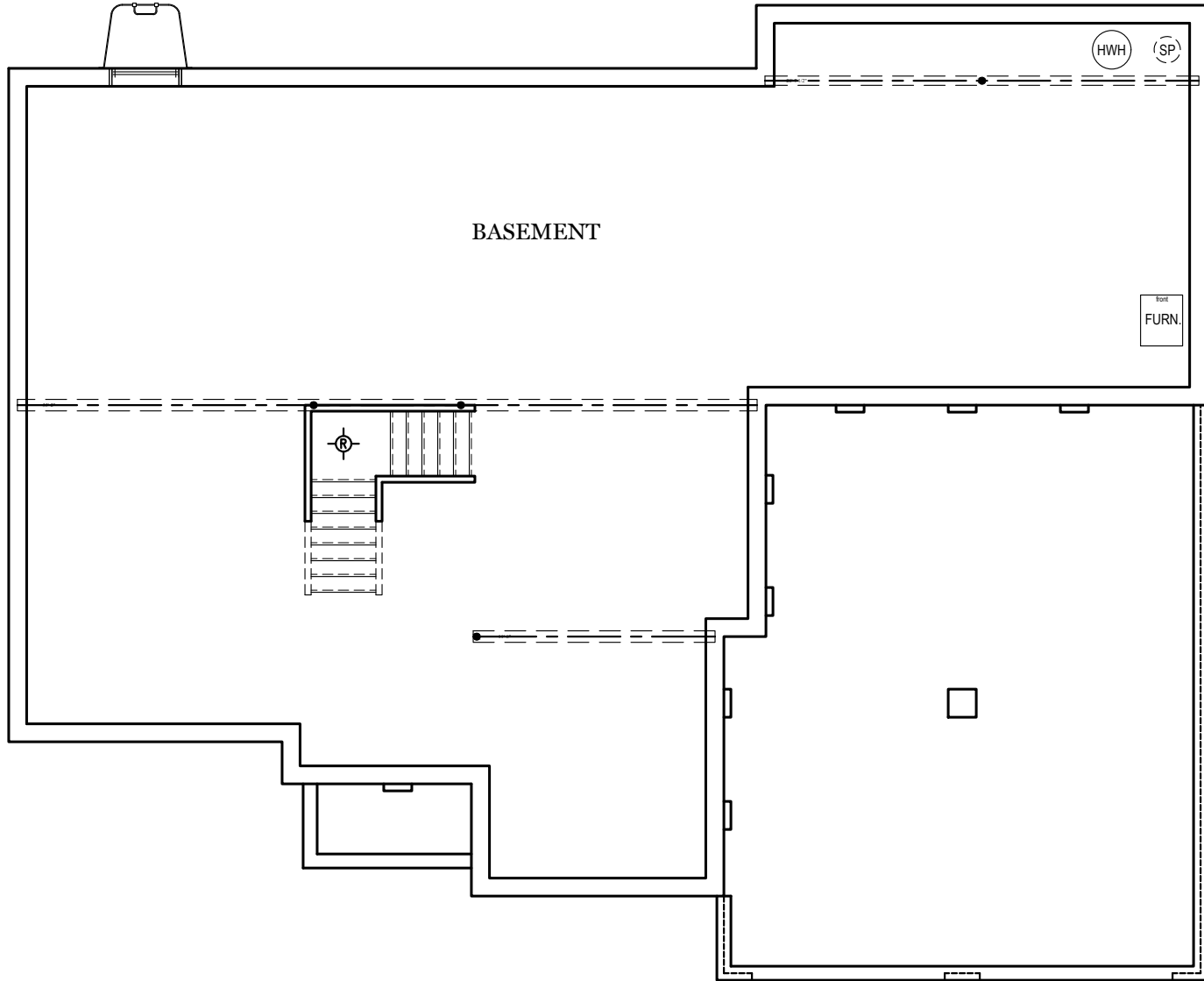

E.G.S. RESERVES THE RIGHT TO RELOCATE MECHANICALS AS REQ. BY SITE CONDITIONS

ALL IMAGES ARE FOR ARTISTIC PURPOSES ONLY AND MAY CONTAIN ADDITIONAL FEATURES OR DESIGN OPTIONS NOT AVAILABLE ON ALL HOME PLANS AND IN ALL NEIGHBORHOODS. ROOM SIZE DIMENSIONS AND SQUARE FOOTAGES ARE APPROXIMATE. CONTACT SALES AGENT FOR MORE INFORMATION. TERMS AND CONDITIONS APPLY. [HTTPS://EGSTOLTZFUSHOMES.COM/TERMS-AND-CONDITIONS/](https://EGSTOLTZFUSHOMES.COM/TERMS-AND-CONDITIONS/)

PDF LAST UPDATED 4/1/2024

TRADITIONAL** FLOOR PLAN SHOWN

Foundation

MAGNOLIA

■ = CARPETED AREA

⊗ = FLUSH MOUNT RECESSED-STYLE LIGHT

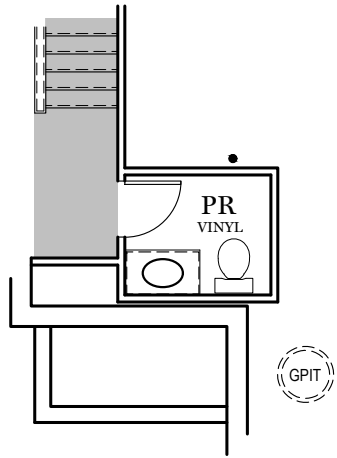

OPTIONAL FINISHED
POWDER ROOM (+36 SF)

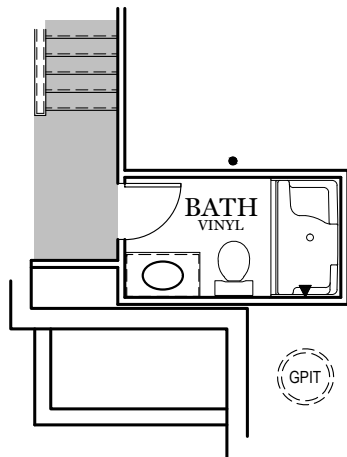

OPTIONAL FINISHED
BATHROOM (+53 SF)

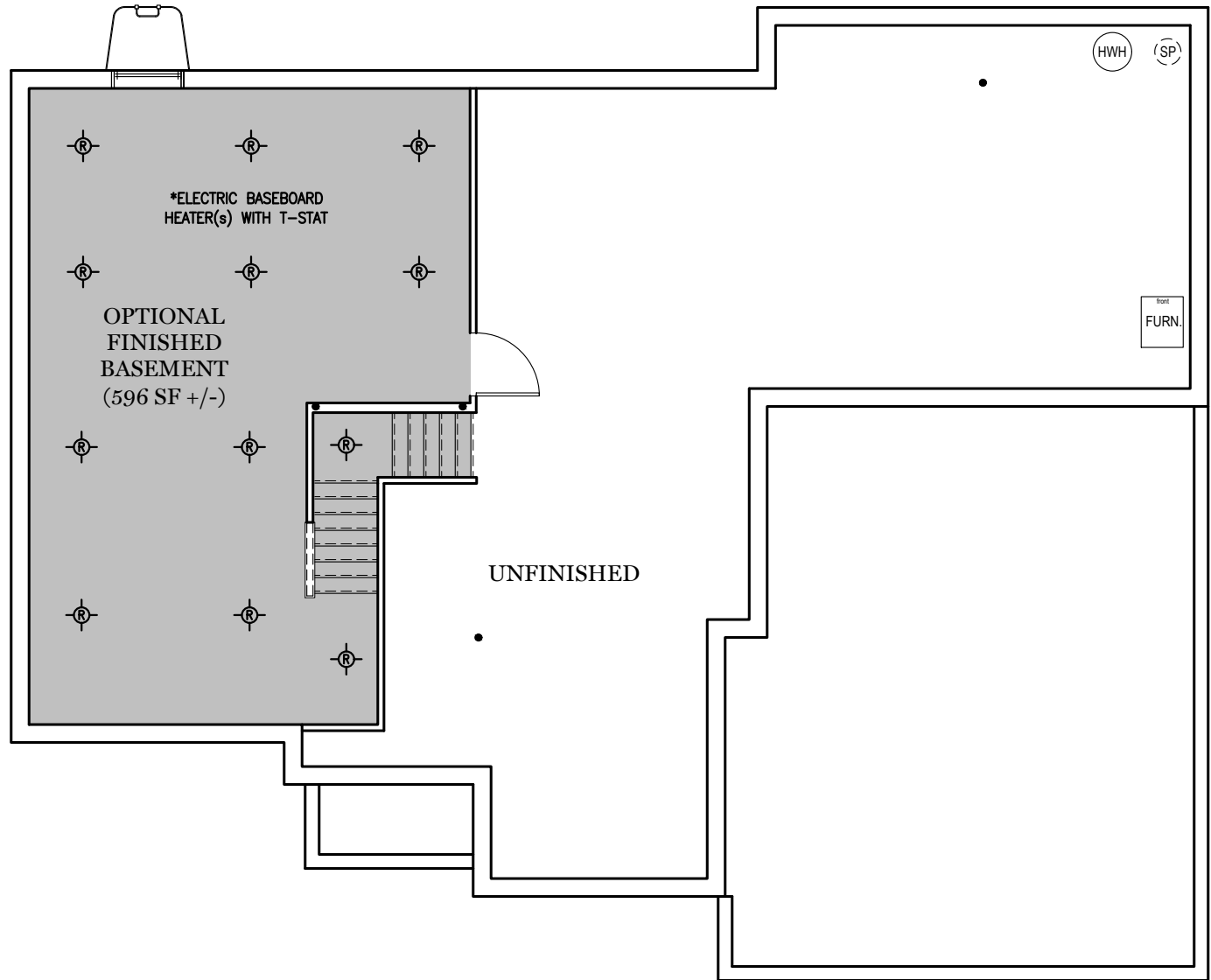

ALL IMAGES ARE FOR ARTISTIC PURPOSES ONLY AND MAY CONTAIN ADDITIONAL FEATURES OR DESIGN OPTIONS NOT AVAILABLE ON ALL HOME PLANS AND IN ALL NEIGHBORHOODS. ROOM SIZE DIMENSIONS AND SQUARE FOOTAGES ARE APPROXIMATE. CONTACT SALES AGENT FOR MORE INFORMATION. TERMS AND CONDITIONS APPLY. [HTTPS://EGSTOLTZFUSHOMES.COM/TERMS-AND-CONDITIONS/](https://EGSTOLTZFUSHOMES.COM/TERMS-AND-CONDITIONS/)



OPTIONAL EXTENDED COVERED PORCH



TRADITIONAL ELEVATION**



OPTIONAL EXTENDED COVERED PORCH



CLASSIC ELEVATION



OPTIONAL EXTENDED COVERED PORCH



AMERICAN ELEVATION



OPTIONAL EXTENDED COVERED PORCH



HERITAGE ELEVATION