

- = CARPETED AREA
- ⊕ = EXTERIOR RECEPTACLE
- HB ⊕ = EXTERIOR HOSE BIBB
- ⊕ (with R) = FLUSH MOUNT RECESSED-STYLE LIGHT
- ⊕ (with circle) = CEILING LIGHT

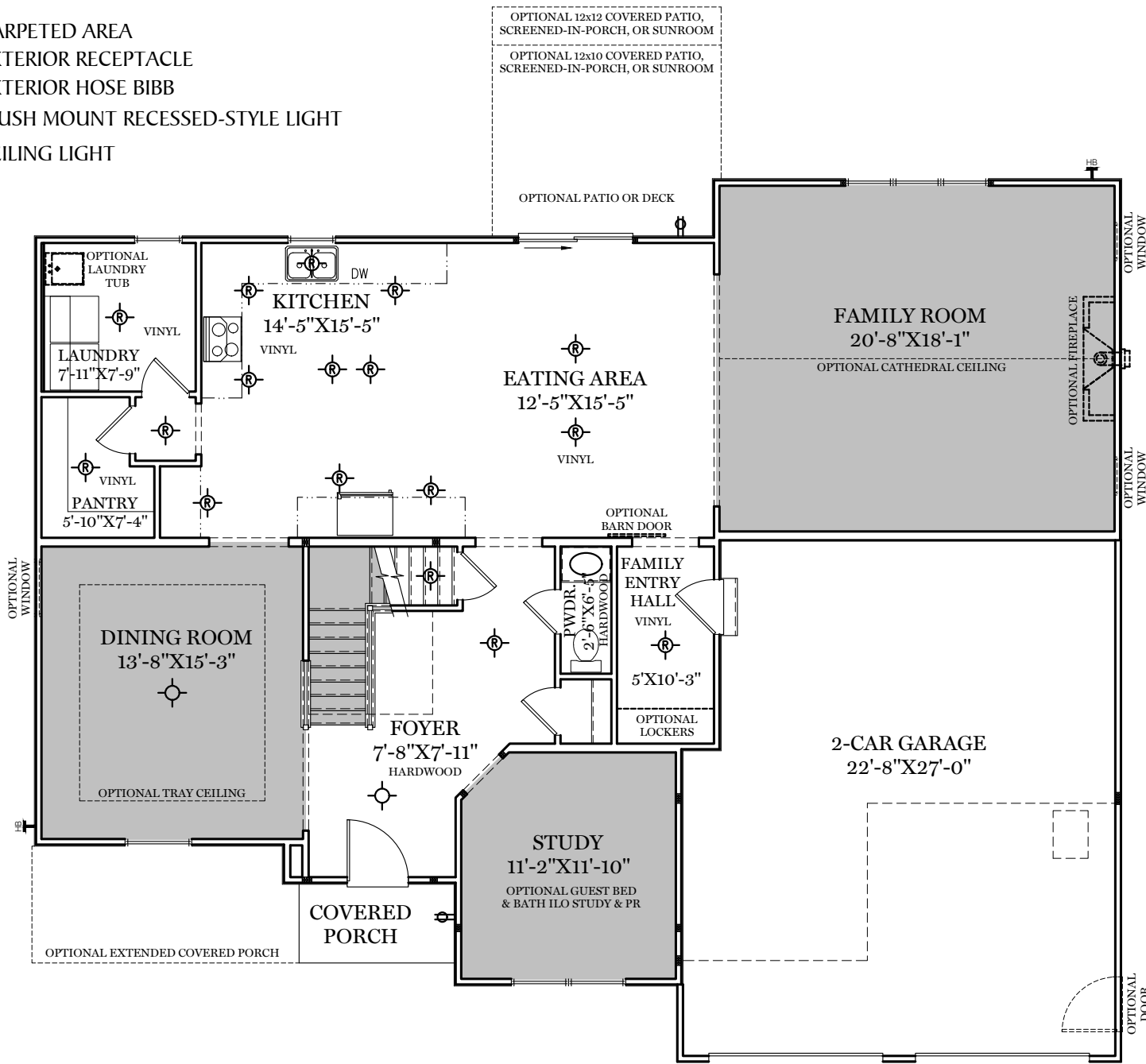

TRADITIONAL\*\* & CLASSIC FLOOR PLAN SHOWN  
**1st Floor Plan - 1,649 sf**  
 MAGNOLIA

ALL IMAGES ARE FOR ARTISTIC PURPOSES ONLY AND MAY CONTAIN ADDITIONAL FEATURES OR DESIGN OPTIONS NOT AVAILABLE ON ALL HOME PLANS AND IN ALL NEIGHBORHOODS. ROOM SIZE DIMENSIONS AND SQUARE FOOTAGES ARE APPROXIMATE. CONTACT SALES AGENT FOR MORE INFORMATION. TERMS AND CONDITIONS APPLY. [HTTPS://EGSTOLTZFUSHOMES.COM/TERMS-AND-CONDITIONS/](https://EGSTOLTZFUSHOMES.COM/TERMS-AND-CONDITIONS/)



\*\* TRADITIONAL FLOOR PLAN ONLY AVAILABLE IN SELECT COMMUNITIES

PDF LAST UPDATED 6/24/2024

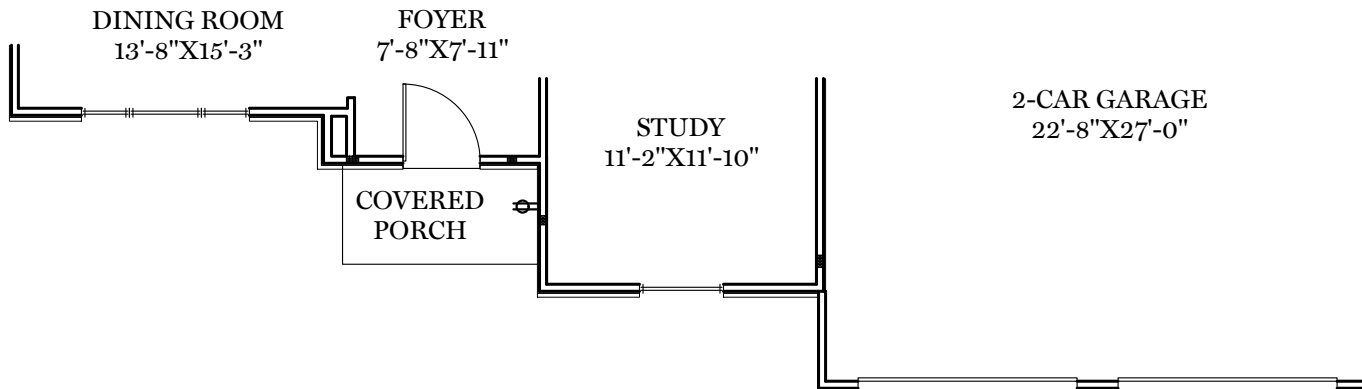

AMERICAN FLOOR PLAN

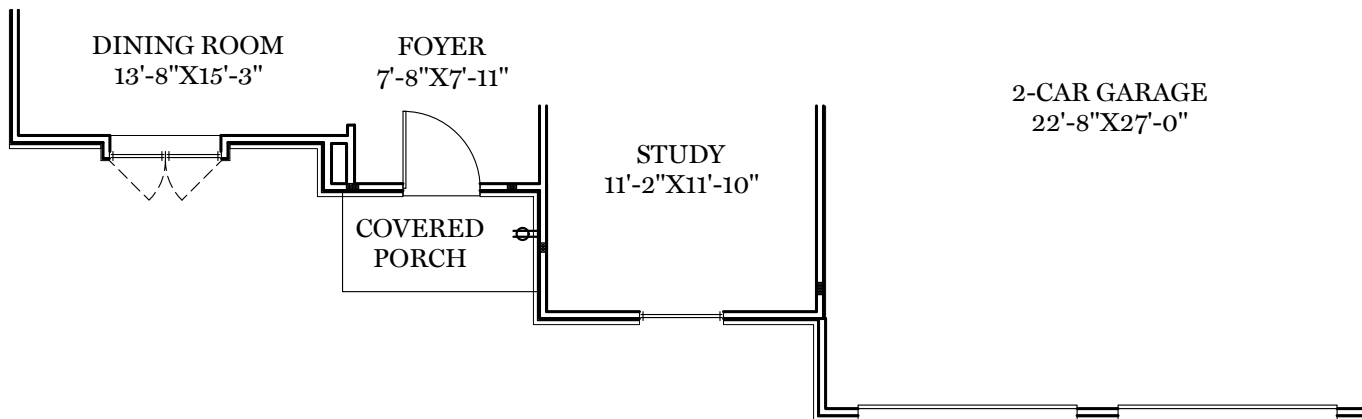

HERITAGE FLOOR PLAN

ALL IMAGES ARE FOR ARTISTIC PURPOSES ONLY AND MAY CONTAIN ADDITIONAL FEATURES OR DESIGN OPTIONS NOT AVAILABLE ON ALL HOME PLANS AND IN ALL NEIGHBORHOODS. ROOM SIZE DIMENSIONS AND SQUARE FOOTAGES ARE APPROXIMATE. CONTACT SALES AGENT FOR MORE INFORMATION. TERMS AND CONDITIONS APPLY. [HTTPS://EGSTOLTZFUSHOMES.COM/TERMS-AND-CONDITIONS/](https://EGSTOLTZFUSHOMES.COM/TERMS-AND-CONDITIONS/)

■ = CARPETED AREA

⊙ = FLUSH MOUNT RECESSED-STYLE LIGHT

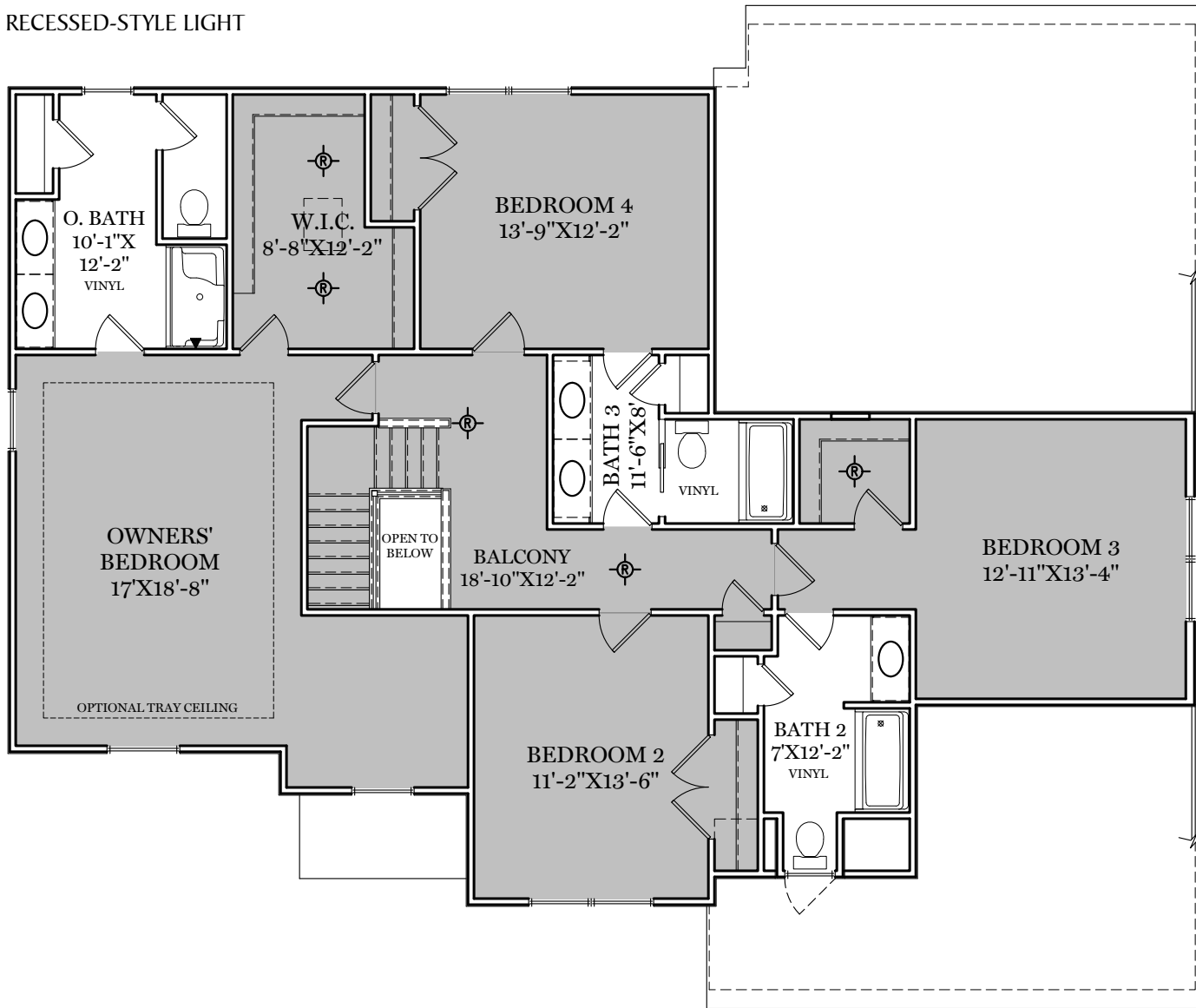

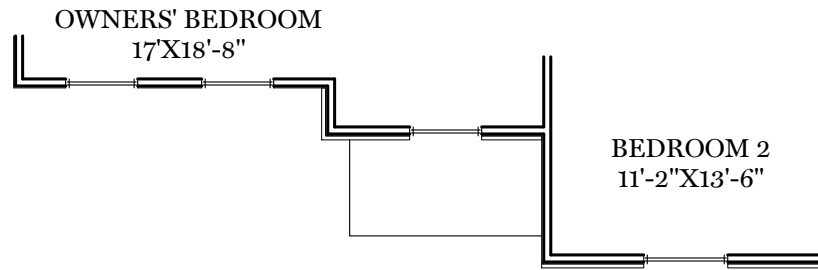

AMERICAN FLOOR PLAN

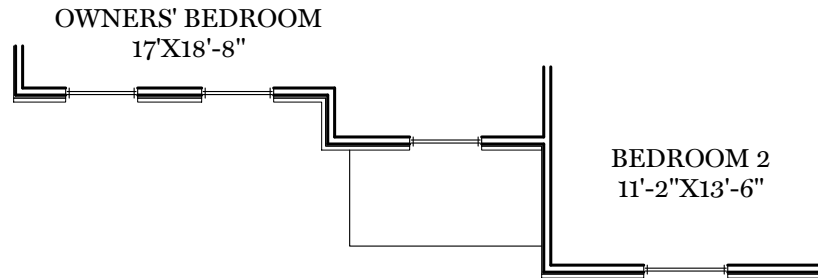

HERITAGE FLOOR PLAN

ALL IMAGES ARE FOR ARTISTIC PURPOSES ONLY AND MAY CONTAIN ADDITIONAL FEATURES OR DESIGN OPTIONS NOT AVAILABLE ON ALL HOME PLANS AND IN ALL NEIGHBORHOODS. ROOM SIZE DIMENSIONS AND SQUARE FOOTAGES ARE APPROXIMATE. CONTACT SALES AGENT FOR MORE INFORMATION. TERMS AND CONDITIONS APPLY. [HTTPS://EGSTOLTZFUSHOMES.COM/TERMS-AND-CONDITIONS/](https://EGSTOLTZFUSHOMES.COM/TERMS-AND-CONDITIONS/)

⊗ = FLUSH MOUNT RECESSED-STYLE LIGHT

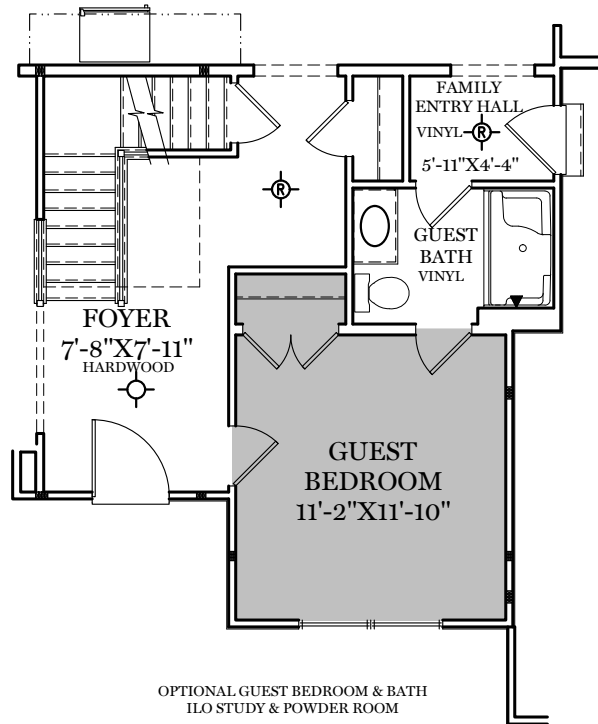
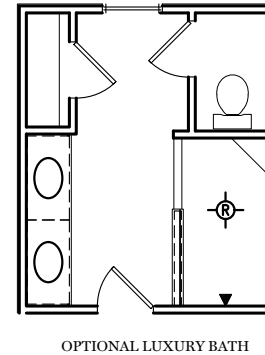
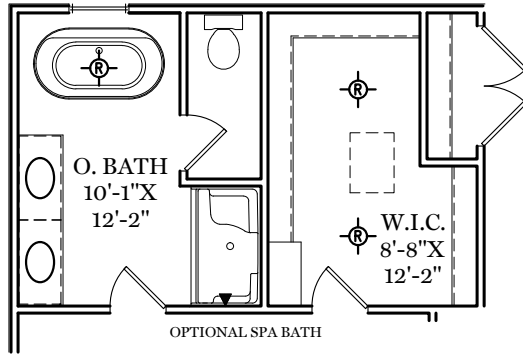

ALL IMAGES ARE FOR ARTISTIC PURPOSES ONLY AND MAY CONTAIN ADDITIONAL FEATURES OR DESIGN OPTIONS NOT AVAILABLE ON ALL HOME PLANS AND IN ALL NEIGHBORHOODS. ROOM SIZE DIMENSIONS AND SQUARE FOOTAGES ARE APPROXIMATE. CONTACT SALES AGENT FOR MORE INFORMATION. TERMS AND CONDITIONS APPLY. [HTTPS://EGSTOLTZFUSHOMES.COM/TERMS-AND-CONDITIONS/](https://egstoltzfushomes.com/terms-and-conditions/)

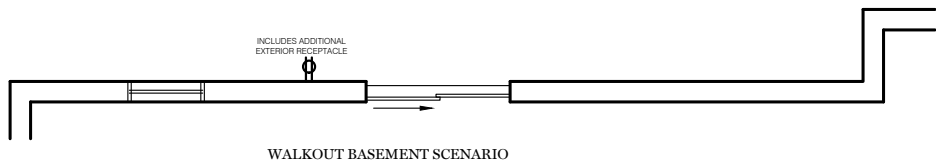

⊗ = FLUSH MOUNT RECESSED-STYLE LIGHT

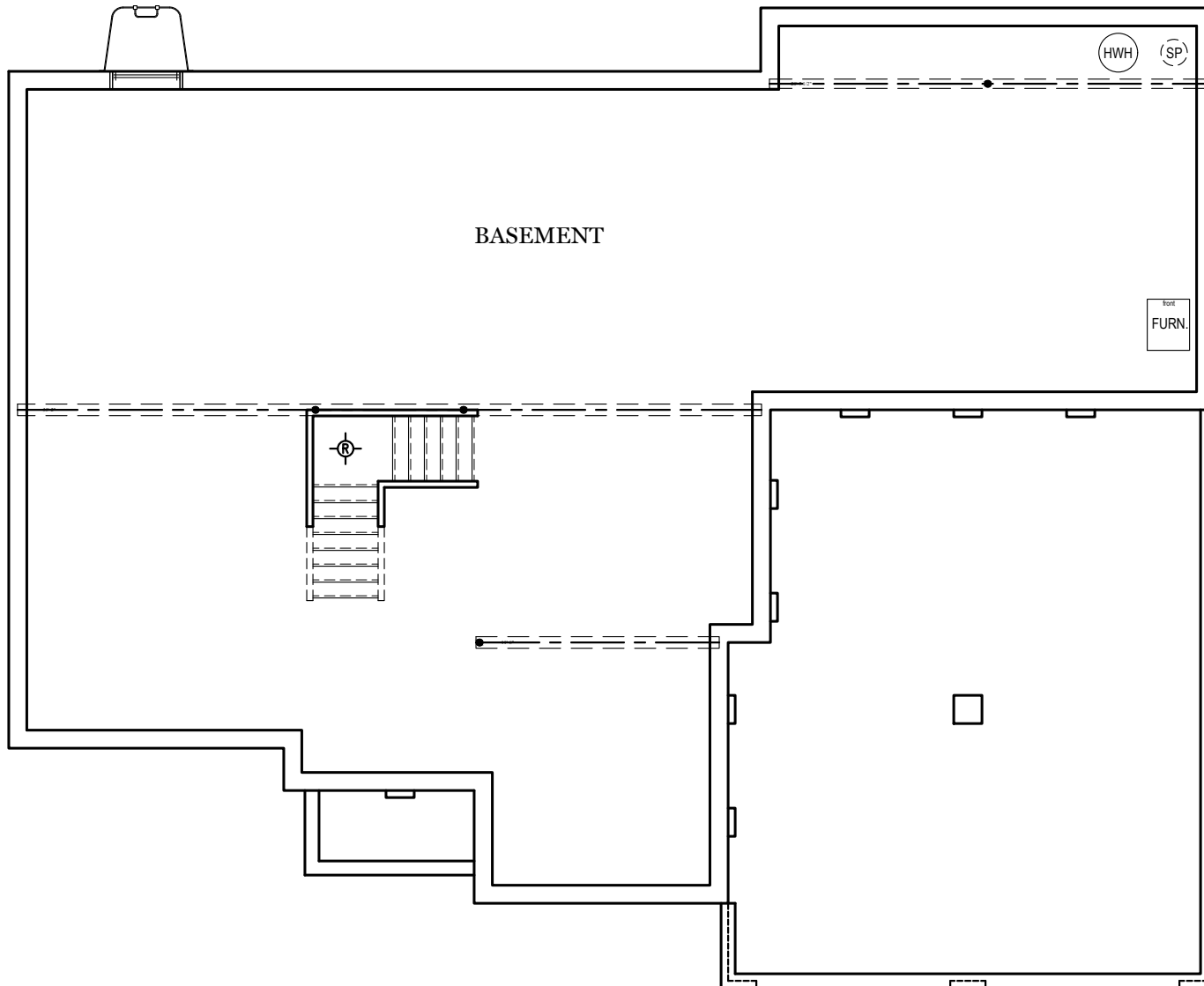

TRADITIONAL\*\* FLOOR PLAN SHOWN

# Foundation

MAGNOLIA

E.G.S. RESERVES THE RIGHT TO RELOCATE MECHANICALS AS REQ. BY SITE CONDITIONS

ALL IMAGES ARE FOR ARTISTIC PURPOSES ONLY AND MAY CONTAIN ADDITIONAL FEATURES OR DESIGN OPTIONS NOT AVAILABLE ON ALL HOME PLANS AND IN ALL NEIGHBORHOODS. ROOM SIZE DIMENSIONS AND SQUARE FOOTAGES ARE APPROXIMATE. CONTACT SALES AGENT FOR MORE INFORMATION. TERMS AND CONDITIONS APPLY. [HTTPS://EGSTOLTZFUSHOMES.COM/TERMS-AND-CONDITIONS/](https://EGSTOLTZFUSHOMES.COM/TERMS-AND-CONDITIONS/)

\*\* TRADITIONAL FLOOR PLAN ONLY AVAILABLE IN SELECT COMMUNITIES

PDF LAST UPDATED 6/24/2024

■ = CARPETED AREA

⊗ = FLUSH MOUNT RECESSED-STYLE LIGHT

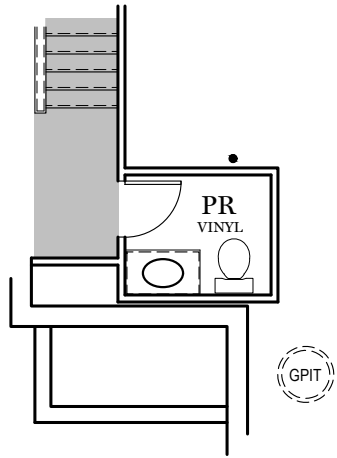

OPTIONAL FINISHED  
POWDER ROOM (+36 SF)

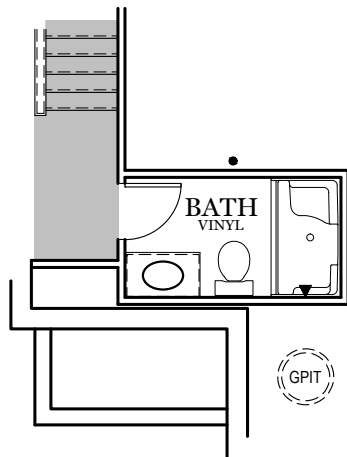

OPTIONAL FINISHED  
BATHROOM (+53 SF)

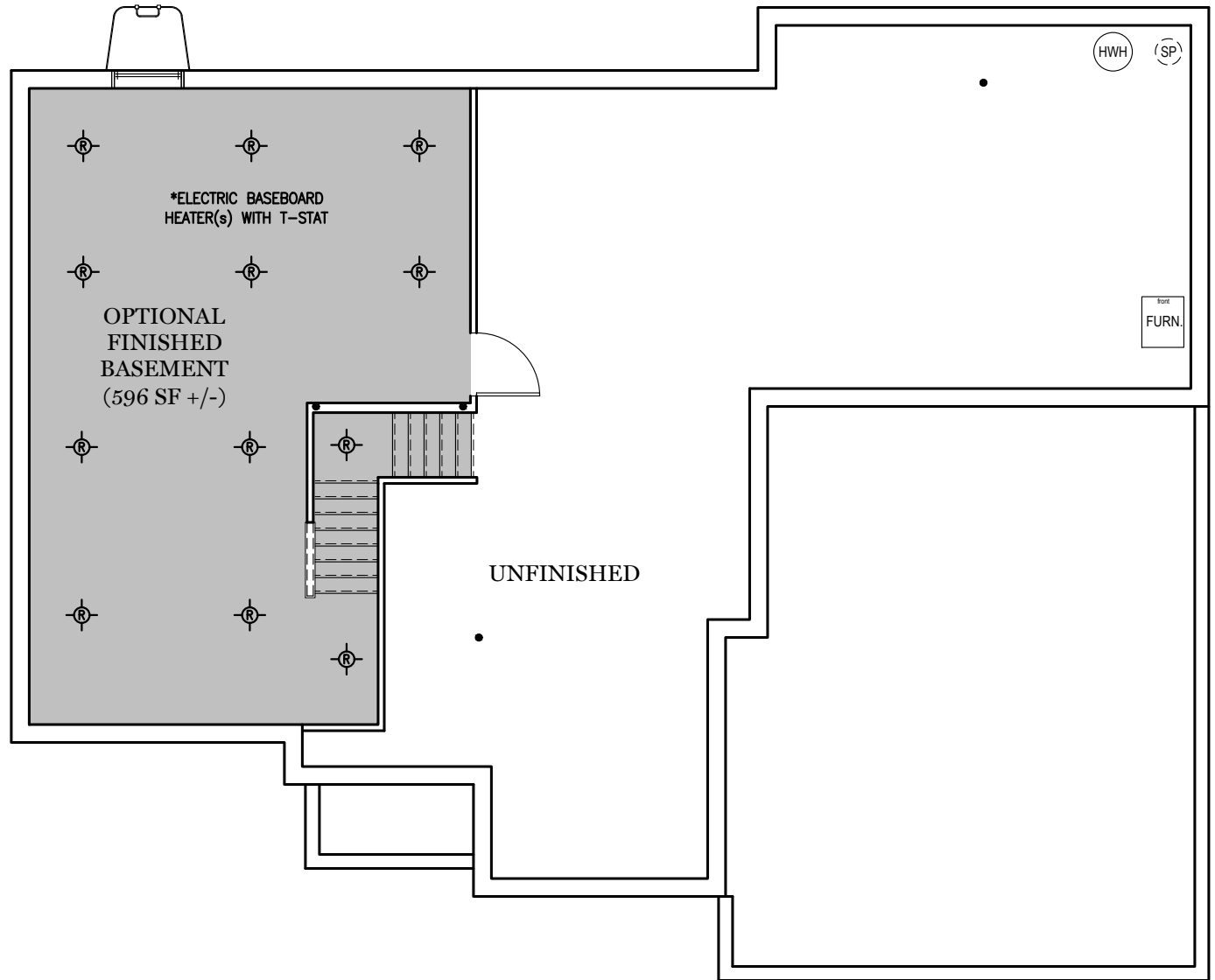

ALL IMAGES ARE FOR ARTISTIC PURPOSES ONLY AND MAY CONTAIN ADDITIONAL FEATURES OR DESIGN OPTIONS NOT AVAILABLE ON ALL HOME PLANS AND IN ALL NEIGHBORHOODS. ROOM SIZE DIMENSIONS AND SQUARE FOOTAGES ARE APPROXIMATE. CONTACT SALES AGENT FOR MORE INFORMATION. TERMS AND CONDITIONS APPLY. [HTTPS://EGSTOLTZFUSHOMES.COM/TERMS-AND-CONDITIONS/](https://EGSTOLTZFUSHOMES.COM/TERMS-AND-CONDITIONS/)



OPTIONAL EXTENDED COVERED PORCH



TRADITIONAL ELEVATION\*\*



OPTIONAL EXTENDED COVERED PORCH



CLASSIC ELEVATION





OPTIONAL EXTENDED COVERED PORCH



AMERICAN ELEVATION



OPTIONAL EXTENDED COVERED PORCH



HERITAGE ELEVATION