

- = CARPETED AREA
- ⊕ = EXTERIOR RECEPTACLE
- HB ⊕ = EXTERIOR HOSE BIBB
- ⊕ (with R) = FLUSH MOUNT RECESSED-STYLE LIGHT
- ⊕ (with C) = CEILING LIGHT

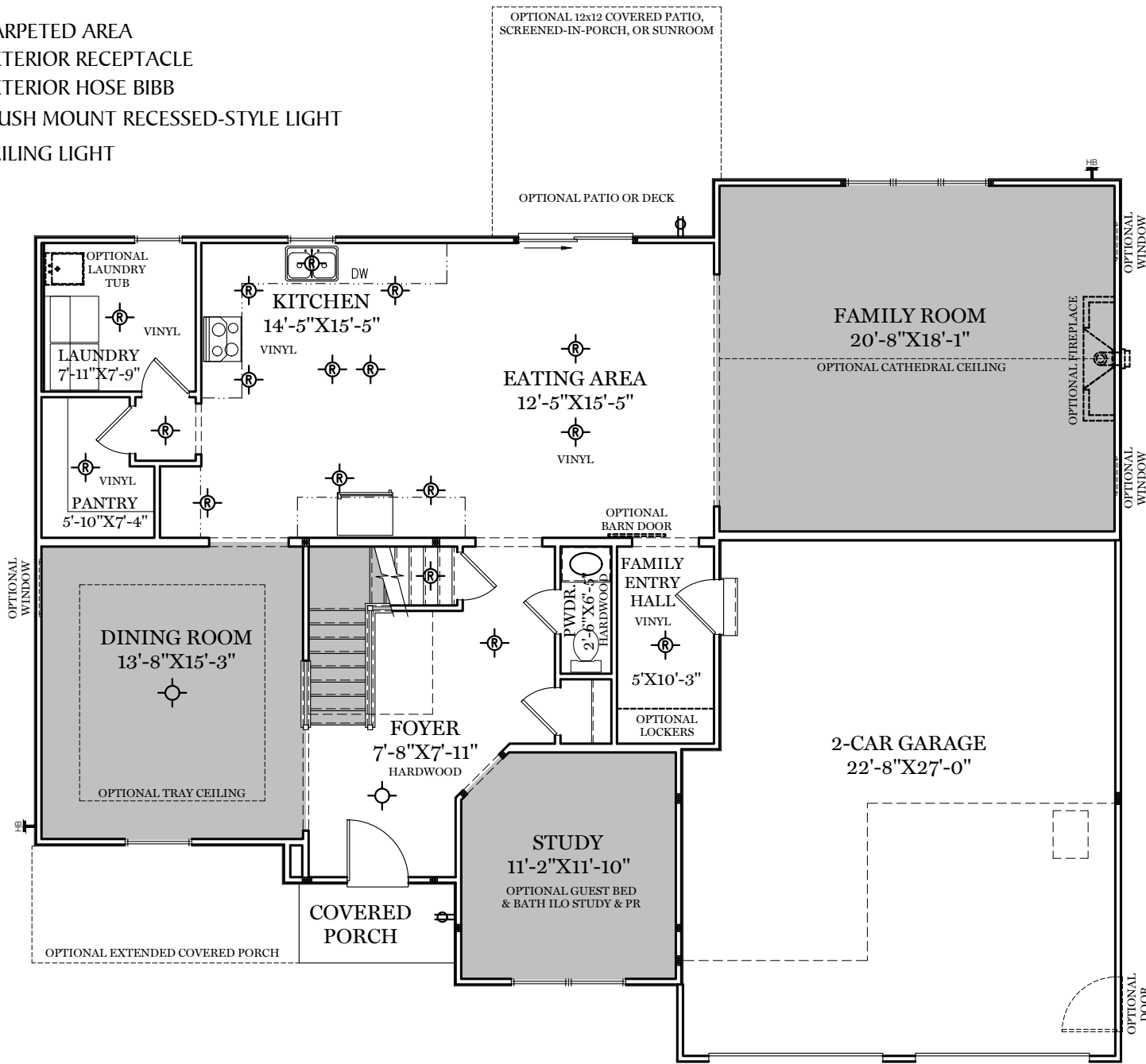

TRADITIONAL** & CLASSIC FLOOR PLAN SHOWN

1st Floor Plan - 1,649 sf

MAGNOLIA

ALL IMAGES ARE FOR ARTISTIC PURPOSES ONLY AND MAY CONTAIN ADDITIONAL FEATURES OR DESIGN OPTIONS NOT AVAILABLE ON ALL HOME PLANS AND IN ALL NEIGHBORHOODS. ROOM SIZE DIMENSIONS AND SQUARE FOOTAGES ARE APPROXIMATE. CONTACT SALES AGENT FOR MORE INFORMATION. TERMS AND CONDITIONS APPLY. [HTTPS://EGSTOLTZFUSHOMES.COM/TERMS-AND-CONDITIONS/](https://EGSTOLTZFUSHOMES.COM/TERMS-AND-CONDITIONS/)

** TRADITIONAL FLOOR PLAN ONLY AVAILABLE IN SELECT COMMUNITIES

PDF LAST UPDATED 1/16/2025



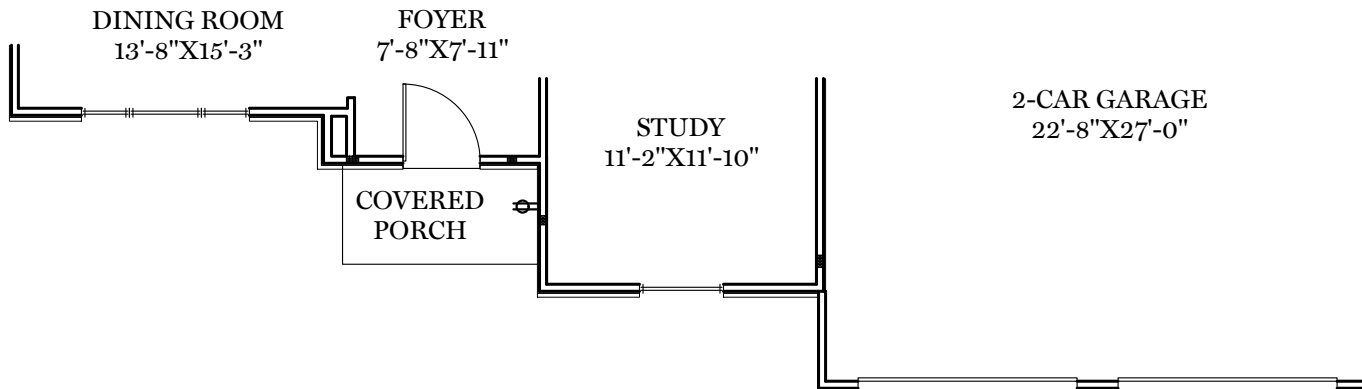

AMERICAN FLOOR PLAN

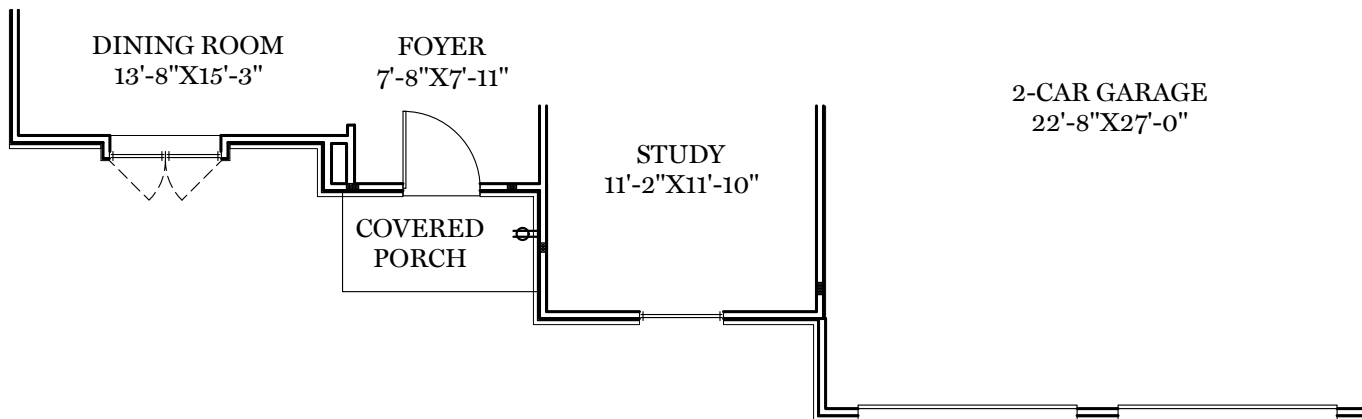

HERITAGE FLOOR PLAN

ALL IMAGES ARE FOR ARTISTIC PURPOSES ONLY AND MAY CONTAIN ADDITIONAL FEATURES OR DESIGN OPTIONS NOT AVAILABLE ON ALL HOME PLANS AND IN ALL NEIGHBORHOODS. ROOM SIZE DIMENSIONS AND SQUARE FOOTAGES ARE APPROXIMATE. CONTACT SALES AGENT FOR MORE INFORMATION. TERMS AND CONDITIONS APPLY. [HTTPS://EGSTOLTZFUSHOMES.COM/TERMS-AND-CONDITIONS/](https://EGSTOLTZFUSHOMES.COM/TERMS-AND-CONDITIONS/)

■ = CARPETED AREA

⊙ = FLUSH MOUNT RECESSED-STYLE LIGHT

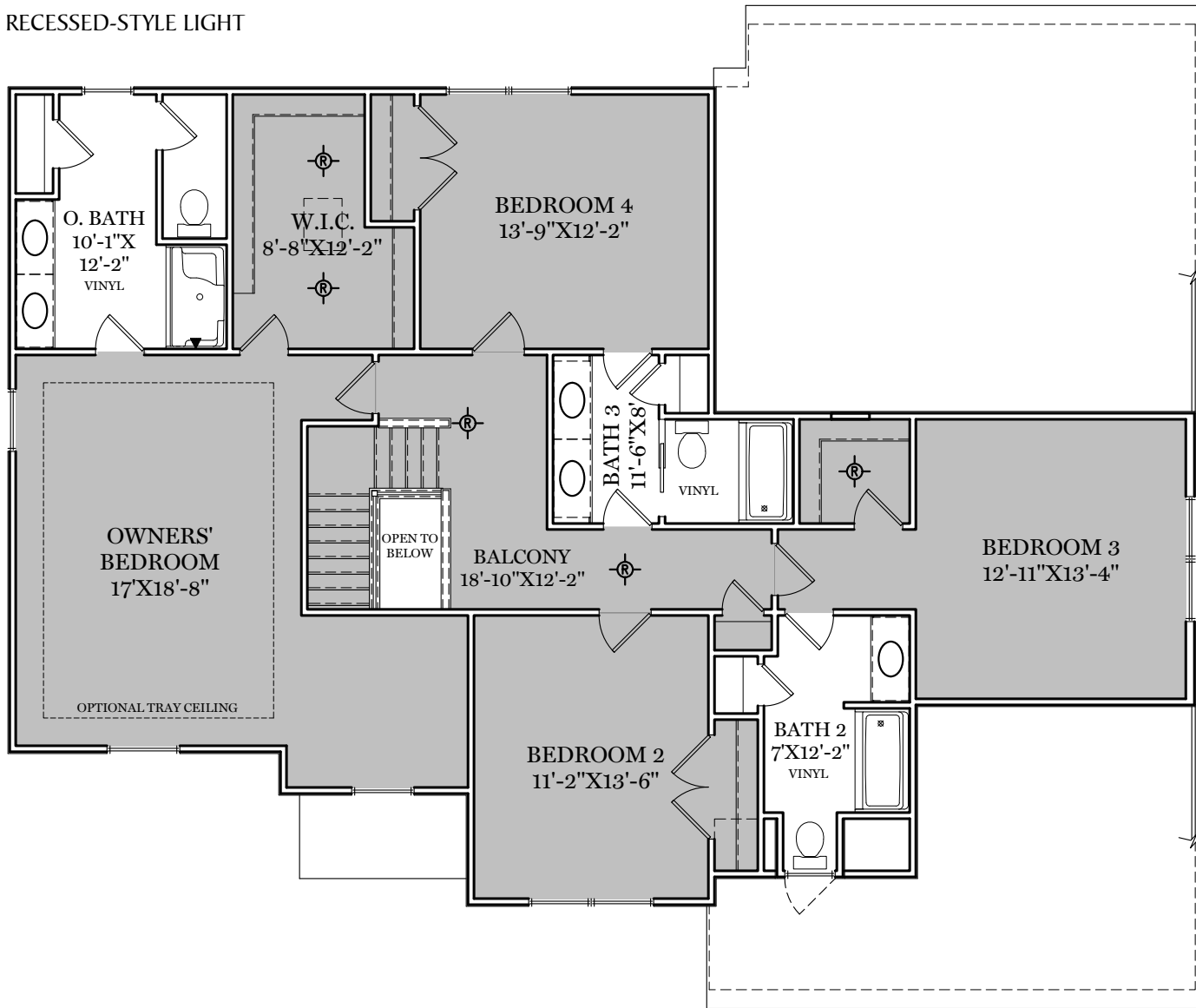

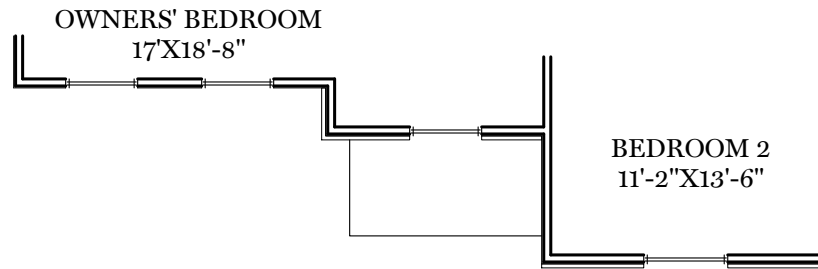

AMERICAN FLOOR PLAN

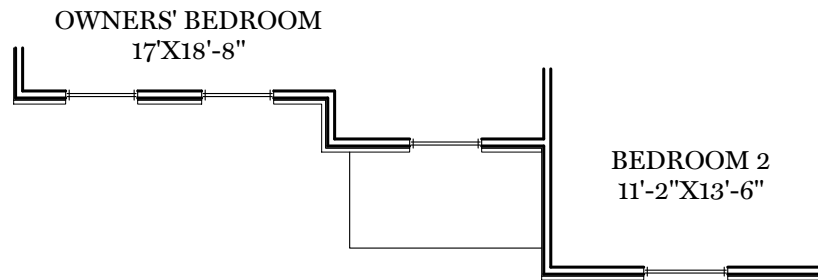

HERITAGE FLOOR PLAN

ALL IMAGES ARE FOR ARTISTIC PURPOSES ONLY AND MAY CONTAIN ADDITIONAL FEATURES OR DESIGN OPTIONS NOT AVAILABLE ON ALL HOME PLANS AND IN ALL NEIGHBORHOODS. ROOM SIZE DIMENSIONS AND SQUARE FOOTAGES ARE APPROXIMATE. CONTACT SALES AGENT FOR MORE INFORMATION. TERMS AND CONDITIONS APPLY. [HTTPS://EGSTOLTZFUSHOMES.COM/TERMS-AND-CONDITIONS/](https://EGSTOLTZFUSHOMES.COM/TERMS-AND-CONDITIONS/)

⊗ = FLUSH MOUNT RECESSED-STYLE LIGHT

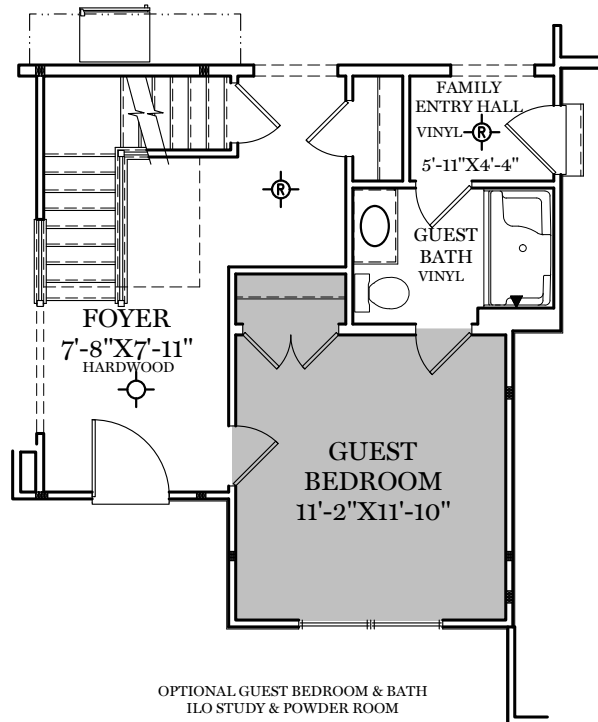
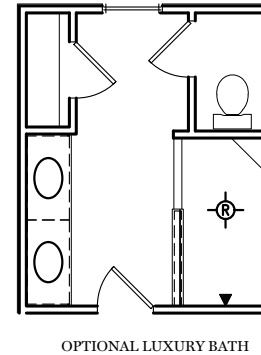
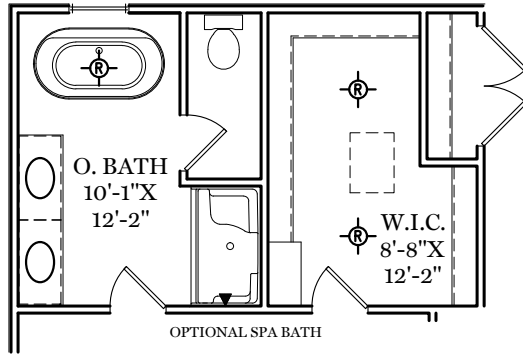

ALL IMAGES ARE FOR ARTISTIC PURPOSES ONLY AND MAY CONTAIN ADDITIONAL FEATURES OR DESIGN OPTIONS NOT AVAILABLE ON ALL HOME PLANS AND IN ALL NEIGHBORHOODS. ROOM SIZE DIMENSIONS AND SQUARE FOOTAGES ARE APPROXIMATE. CONTACT SALES AGENT FOR MORE INFORMATION. TERMS AND CONDITIONS APPLY. [HTTPS://EGSTOLTZFUSHOMES.COM/TERMS-AND-CONDITIONS/](https://egstoltzfushomes.com/terms-and-conditions/)

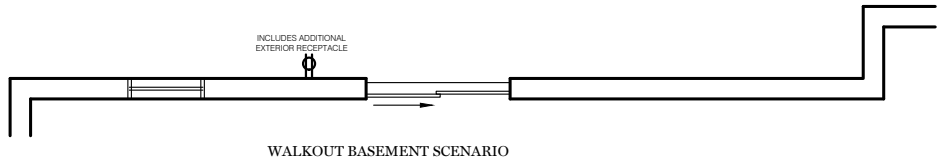

⊗ = FLUSH MOUNT RECESSED-STYLE LIGHT

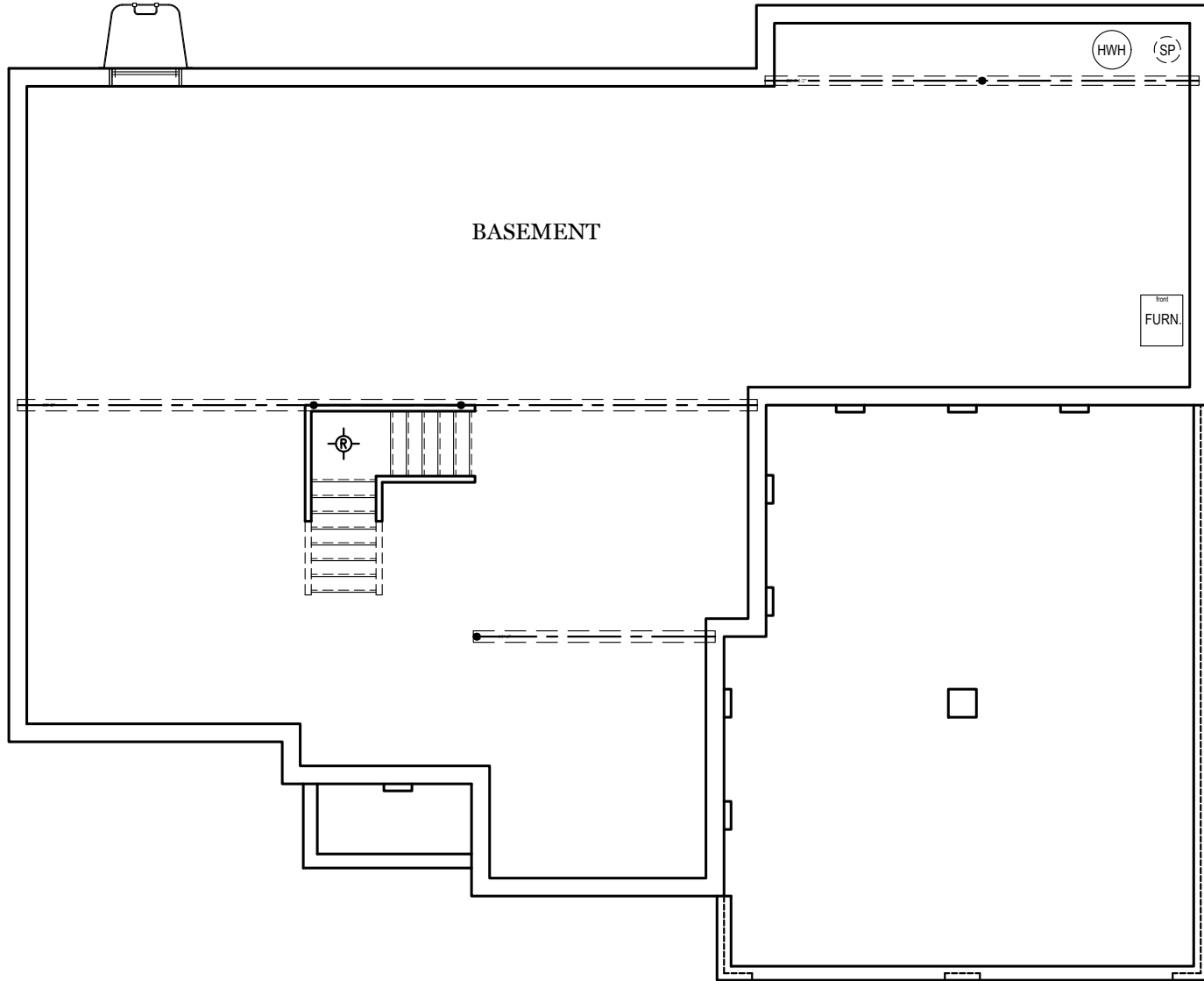

E.G.S. RESERVES THE RIGHT TO RELOCATE MECHANICALS AS REQ. BY SITE CONDITIONS

ALL IMAGES ARE FOR ARTISTIC PURPOSES ONLY AND MAY CONTAIN ADDITIONAL FEATURES OR DESIGN OPTIONS NOT AVAILABLE ON ALL HOME PLANS AND IN ALL NEIGHBORHOODS. ROOM SIZE DIMENSIONS AND SQUARE FOOTAGES ARE APPROXIMATE. CONTACT SALES AGENT FOR MORE INFORMATION. TERMS AND CONDITIONS APPLY. [HTTPS://EGSTOLTZFUSHOMES.COM/TERMS-AND-CONDITIONS/](https://EGSTOLTZFUSHOMES.COM/TERMS-AND-CONDITIONS/)

PDF LAST UPDATED 1/16/2025

TRADITIONAL** FLOOR PLAN SHOWN

Foundation

MAGNOLIA

■ = CARPETED AREA

⊗ = FLUSH MOUNT RECESSED-STYLE LIGHT

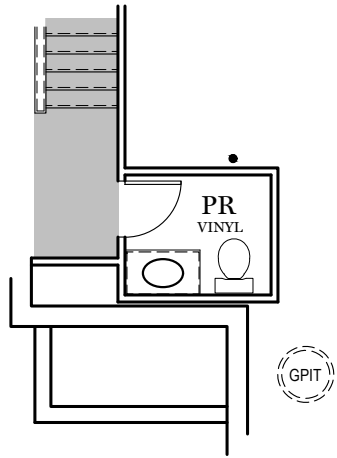

OPTIONAL FINISHED
POWDER ROOM (+36 SF)

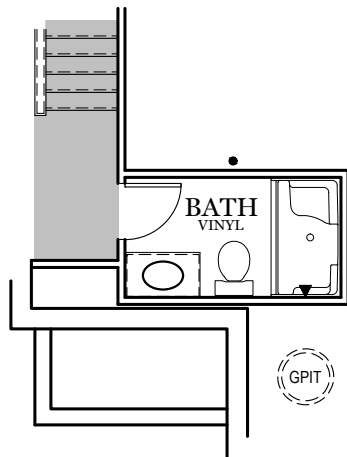

OPTIONAL FINISHED
BATHROOM (+53 SF)

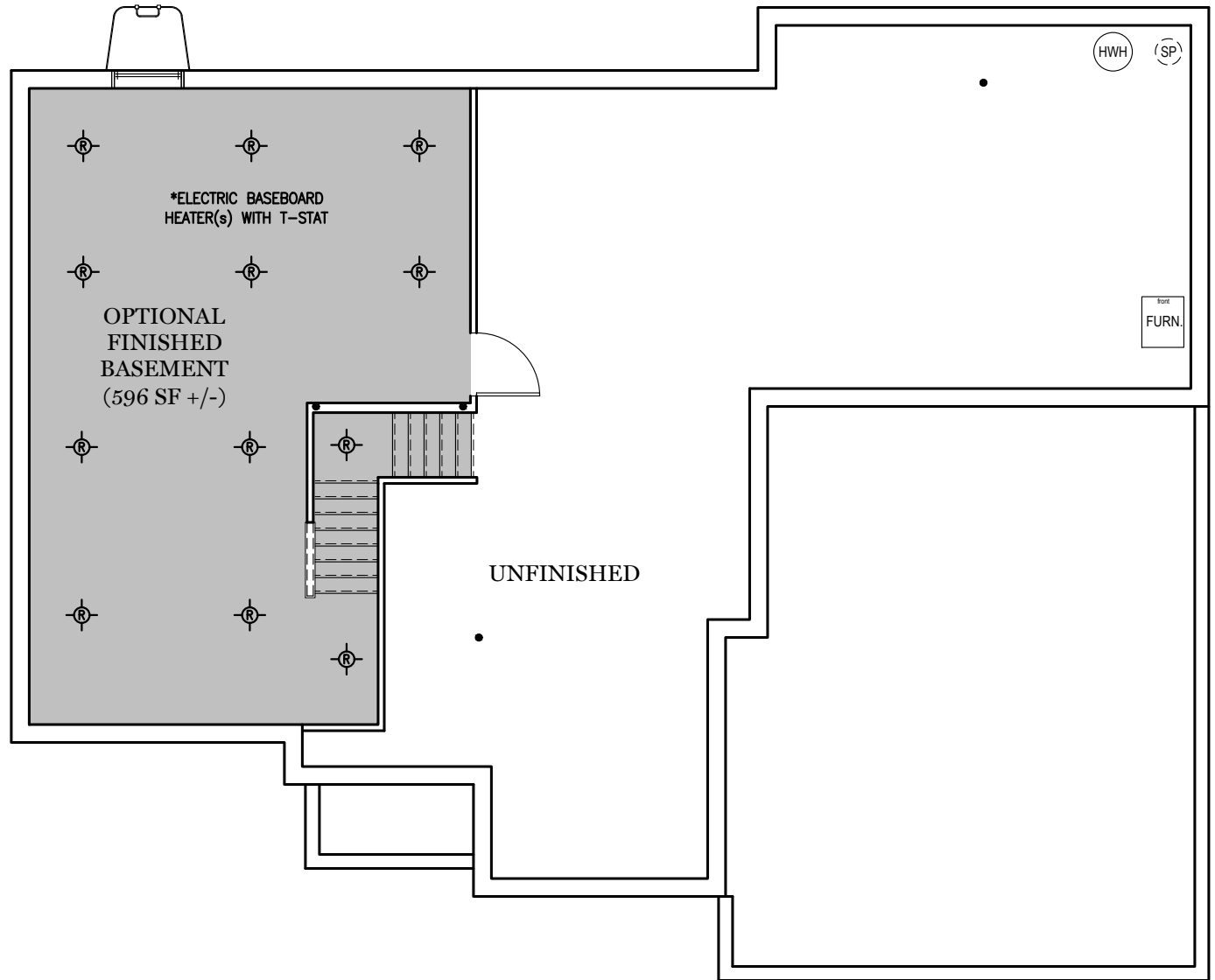

ALL IMAGES ARE FOR ARTISTIC PURPOSES ONLY AND MAY CONTAIN ADDITIONAL FEATURES OR DESIGN OPTIONS NOT AVAILABLE ON ALL HOME PLANS AND IN ALL NEIGHBORHOODS. ROOM SIZE DIMENSIONS AND SQUARE FOOTAGES ARE APPROXIMATE. CONTACT SALES AGENT FOR MORE INFORMATION. TERMS AND CONDITIONS APPLY. [HTTPS://EGSTOLTZFUSHOMES.COM/TERMS-AND-CONDITIONS/](https://EGSTOLTZFUSHOMES.COM/TERMS-AND-CONDITIONS/)



OPTIONAL EXTENDED COVERED PORCH



TRADITIONAL ELEVATION**



OPTIONAL EXTENDED COVERED PORCH



CLASSIC ELEVATION



OPTIONAL EXTENDED COVERED PORCH



AMERICAN ELEVATION



OPTIONAL EXTENDED COVERED PORCH



HERITAGE ELEVATION